

# DIGIFORCE® X/Y monitoring

## For monitoring press-fit, joining, rivet and caulking operations

### Series 9311

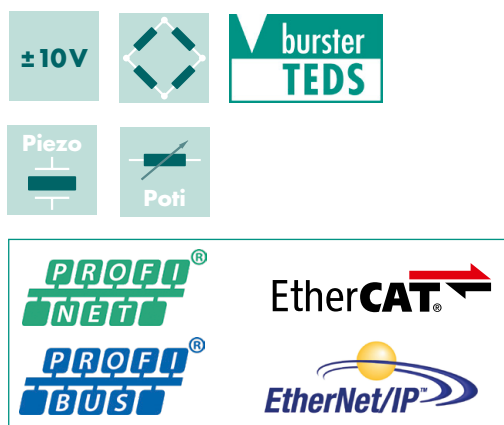

- Flexible Fieldbus integration by PROFIBUS, PROFINET, EtherNet/IP or EtherCAT
- Automatic sensor recognition from burster TEDS
- 3.5" colour touchscreen display
- 16 measurement programs
- Rapid data logging on USB flash drive
- User-configurable I/Os and 6 real-time switching signals
- Smart autosetup for evaluation elements

- Handles worker, admin and identification data
- Up to 50 most recent measurements available for display and analysis
- Records and evaluates a forward and return curve
- Live sensor values provided at the Fieldbus interface
- Synchronous logging of measurement data using DigiControl PC software for multichannel applications
- Cabinet version available without display

### Application

DIGIFORCE® 9311 is the new standard in efficient quality control. The pioneering force/displacement controller delivers rapid, precise evaluation results for applications that demand both high quality and high productivity. The smart performance features and intelligent hardware make test equipment quicker to set up, easier to use and capable of automatic integration in modern production systems. This unrivalled product specification gives businesses the added security and dependability they need for increasingly complex production processes. The DIGIFORCE® 9311 monitors processes in which precisely defined functional relationships need to be demonstrated between two measured quantities of the process. For instance when recording and monitoring processes such as press-insertion, joining, riveting, stamping or caulking, reliable quality control depends on synchronous and high-speed acquisition of measured values combined with analysis based on versatile evaluation elements. DIGIFORCE® 9311 provides the modern platform you need for this task, offering the widest choice of Fieldbus interfaces, including PROFINET, PROFIBUS, EtherNet/IP and EtherCAT, to let you integrate the test setup in your particular control environment.

Even in fully manual workstations such as manual presses with force/displacement monitoring, DIGIFORCE® 9311 can be used for convenient and efficient process monitoring thanks to custom add-on functions like acknowledge and inhibit signals.

The DIGIFORCE® 9311 uses burster TEDS to provide automatic sensor recognition. This feature automatically reads an electronic datasheet stored in the sensor so that the relevant data can be used in the measurement-channel configuration. With no chance of operator error during setup or servicing, it's best to play safe with burster TEDS. DIGIFORCE® 9311 offers versatile solutions for processes that need not just an OK/NOK evaluation but also data logging capabilities for recorded measurements and curves. Data from semi-automated and fully automated systems can be logged via the available Fieldbuses without slowing down production or via the Ethernet port (included as standard) linked to a server, host or local PC. The DigiControl PC software provides support with an automatic data logging mode that runs in parallel with production. There is also the option for high-speed data acquisition on a USB flash drive.

**Block diagram**

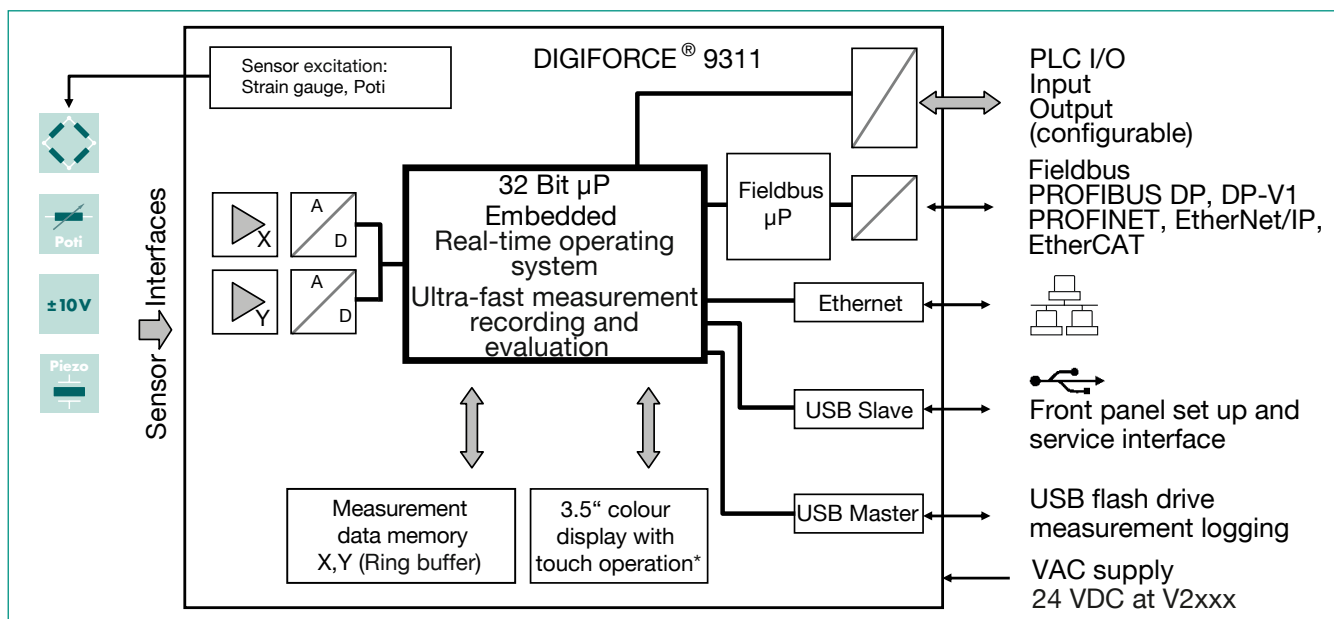

\* is omitted in the version V2xxx

**Measurement data acquisition**

With an active measurement, which can be triggered by different events, the synchronously measured quantities X,Y are saved in the measurement data memory. Real-time signals can indicate whether measurements are exceeding set signal levels while the measurement is still in progress. The evaluation phase follows immediately after the measurement. In this phase, DIGIFORCE 9311 checks whether the recorded measurement curve satisfy the stored graphical evaluation criteria. If any of these criteria has been infringed, the measurement is classified as BAD (NOK), otherwise it is rated as GOOD (OK). Once this evaluation is complete, the measurement curve, the global OK or NOK result and numerous process-related values are displayed in a suite of measurement windows and updated at the Fieldbus interface. The processing steps of the evaluation phase, which finishes when the equipment is ready for the next measurement, have been optimized so that even dynamic manufacturing processes can be monitored.

**Evaluation of a measurement curve**

As a universal evaluation tool for a vast range of measurement curves, the DIGIFORCE 9311 provides configurable evaluation elements, which can be used to classify a measurement curve as OK or NOK. In addition to the traditional evaluation windows with defined entry and exit sides, the DIGIFORCE 9311 also uses thresholds, trapeziums of type X or Y and envelopes as graphical evaluation elements. The graphical evaluation elements can be configured both numerically and graphically in setup mode using one or more recorded measurement curves. They can be used in any combination, even overlapping in an X/Y graph.

**Window evaluation element**

Symbol

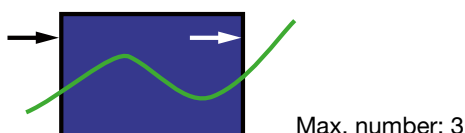

The Window evaluation element tests whether the curve has passed through the defined entry side and exit side in the window area. The user can configure these entry/exit sides as required, and can even set multiple input/output sides. A live signal can be assigned to one window, which is enabled immediately during recording if any infringement occurs. It is also possible to define windows of type NOT (no entry/exit) or BLOCK (curve ends inside the window) by suitable configuration of the entry/exit sides. The path of the X/Y curve through the window area is always analysed both for entry and exit coordinates and the absolute minimum and maximum points.

Examples of window types:

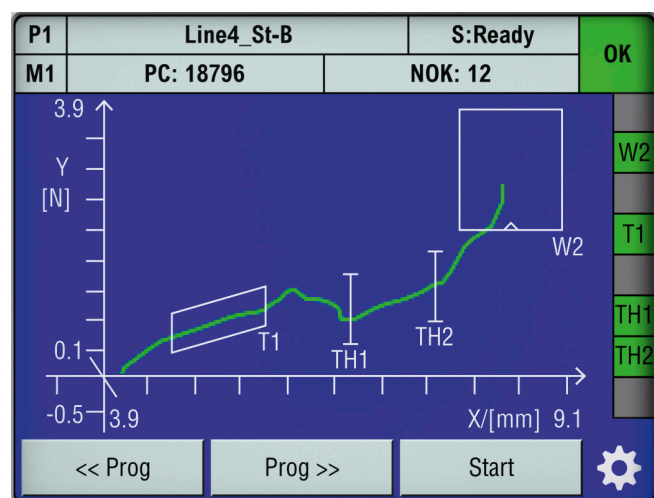
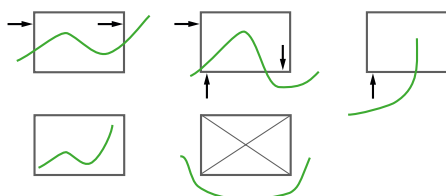
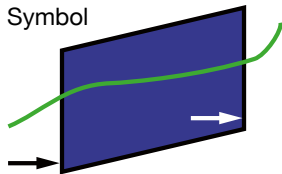

Figure: Measurement dialog M1: graphical display of measurement curve:  
This screen shows the curve in a typical press-insertion process up to an end-point force YMAX. In this example, a trapezoid window and two threshold elements monitor the sliding-contact zone. The window (W2) ensures that the end-point force lies in the correct displacement range.

## Trapezium evaluation element

Symbol



Max. number: 2

The DIGIFORCE® 9311 offers two different types of trapezium: the type-X trapezium window with fixed XMIN, XMAX limits and type-Y trapezium with fixed YMIN, YMAX limits. The trapezium evaluation element tests whether the curve has passed through the defined entry and exit sides; only one entry side can be configured for this element. The entry/exit values are calculated.

Examples of trapezium types:

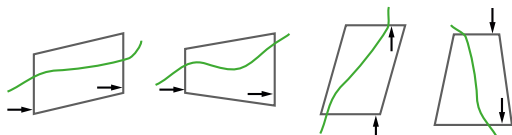

## Threshold evaluation element

Symbol

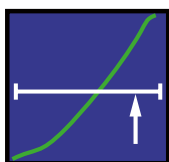

Max. number: 2

The threshold evaluation element can be used to calculate and monitor where the measurement curve passes through a defined X-value or Y-value. The user can choose between threshold type X or Y.

Examples of threshold types:

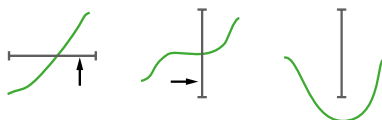

## Envelope evaluation element

Symbol

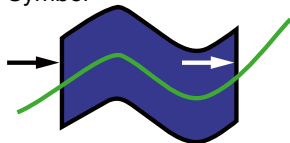

Max. number: 1

The DIGIFORCE® 9311 can use one or more measurement curves to generate one envelope. The user can then customize a generated envelope in the X-domain, and also set tolerances for the Y-domain. For a measurement curve comprising a forward and return curve section, the envelope cannot lie over the turning point.

When subsequently monitoring a measurement in measurement mode, DIGIFORCE® tests whether the measurement curve lies within the defined envelope band i.e. is classified OK, or whether the curve passes outside the valid envelope and hence must be classified NOK.

## Measuring programs

With the capability to handle 16 measuring programs, the DIGIFORCE® 9311 can switch quickly and flexibly between different component versions and/or joining parameters. The measuring programs can be selected via I/O, Fieldbus or even the Ethernet port. Sensors can be configured individually in each measuring program or using global settings.

## Flexible process integration

The DIGIFORCE® 9311 has the versatility to integrate into practically all process environments. A huge number of detailed requirements can be implemented using the numerous I/Os (10 inputs / 13 outputs), some of which can be assigned user-defined functions. A measurement can be started and terminated at variable times by different internal or external events.

## Fieldbus interface

An independent communications processor provides an optional Fieldbus interface via PROFIBUS, PROFINET or EtherNet/IP.

Cyclical real-time data

- ▶ Process control
- ▶ Retrieval of specific measurement results
- ▶ Live values from active sensors

Acyclical data for parameters, ADMIN and results

- ▶ Transfer of component/worker/job data for logging
- ▶ Complete device configuration
- ▶ Retrieval of large amounts of process and curve data

## Sampling and recording measurement signals

Signals can be sampled as a combination of time interval ( $\Delta t$ ), X-interval and Y-interval ( $\Delta X$ ,  $\Delta Y$ ) to provide a flexible yet also compressed measurement recording. Curve areas containing a constant or steadily changing signal can be reproduced with just a few stored measurement points, while steep signal slopes or alternating waveforms require many points.

## Start/Stop conditions for measurement recording

The DIGIFORCE® 9311 lets the user define independent start/stop logic.

- ▶ Start conditions: Ext. control signal, measurement above or below a definable X-value or Y-value.
- ▶ Stop conditions: Ext. control signal, measurement above or below a definable X-value or Y-value, timeout, definable number of recorded measurements reached.

## Limit monitoring in real time

S1 ... S6

The user is able to assign the switching signals S1 ... S6 to the two measurement channels as required, and can set their polarity. The associated PLC I/Os and Fieldbus signals are updated both in standby mode and also in real time during the measurement cycle (typ. response time < 3 ms).

NOK-ONLINE

The live signals OUT\_NOK\_ONL can be used if the curve does not pass through the permitted region of the window evaluation element. This allows pre-emptive termination of a joining process in ultra-quick time if the two components processed incorrect, protecting parts, tools or even the entire system from damage.

**Process data**

The DIGIFORCE® 9311 visualizes a comprehensive set of process data during measurement mode and automatic production mode\*. All relevant process data can be transferred to the controller or PC environment immediately after a measurement. The user can switch between the following process windows:

- ▶ M1 Graph of measurement curve
- ▶ M2 General display of Y(X) curves
- ▶ M3 Full-screen PASS/FAIL or smiley
- ▶ M4 Entry/exit data for evaluation elements
- ▶ M5 List of user-specific process values (up to 20 values)
- ▶ M6 Statistics on all graphical evaluation elements
- ▶ M7 Job sheet containing process, worker and parts data

Each process window displays the global header containing information on the selected measurement program, the associated part quantities and NOK figures, and the global OK/NOK evaluation. The status field on the right shows the evaluation elements that are active in the measurement program and their individual results. The user can customize the buttons at the bottom of the Process dialog touchscreens with particular device functions. Alternatively, the live values from the X/Y measurement channels can also be displayed here.

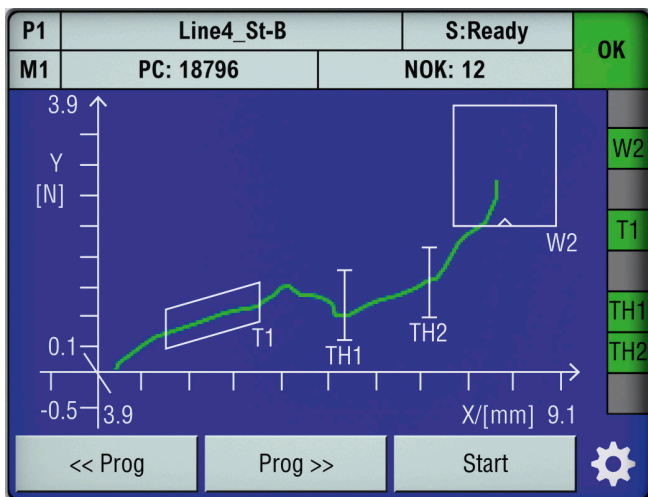

Figure: M1 – graphical display of measurement curve  
The function keys can optionally be displayed at the bottom of the screen.

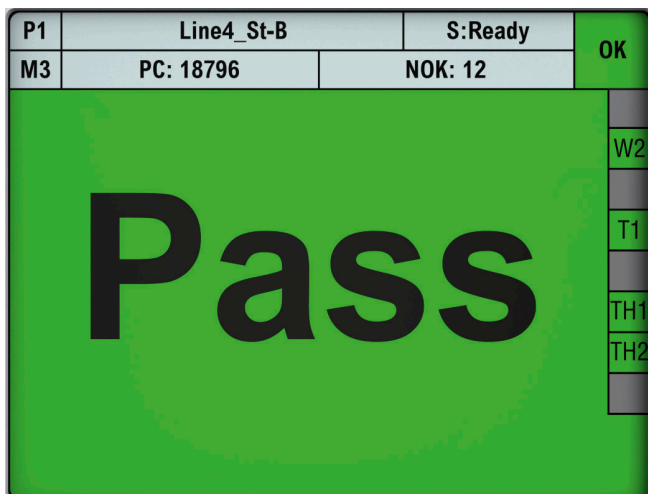

Figure: PASS/FAIL full-screen display  
A large OK/NOK smiley can be used as an alternative indicator.

**M5 – List of user-specific process values**

Users can customize their own process values in each measurement program. They can personally enter numerous different result values, for instance a force maximum inside the window and/or tolerance limits for the window. The values in this list are transmitted to the Fieldbuses directly with the OK/NOK evaluation. In addition, the measured values are also issued for logging on USB flash drive and for the Excel statistics export in the DigiControl PC software.

**Device configuration**

Device parameters can be fully configured either via the touch-screen display\* or using the DigiControl PC software (available free of charge). From any of the process screens M1 to M7, you can press the cog icon to access the main configuration level containing the following functions:

- ▶ Basic setup
- ▶ Measurement program selection
- ▶ Measurement program configuration
- ▶ Curve analysis
- ▶ Measurement program copy function

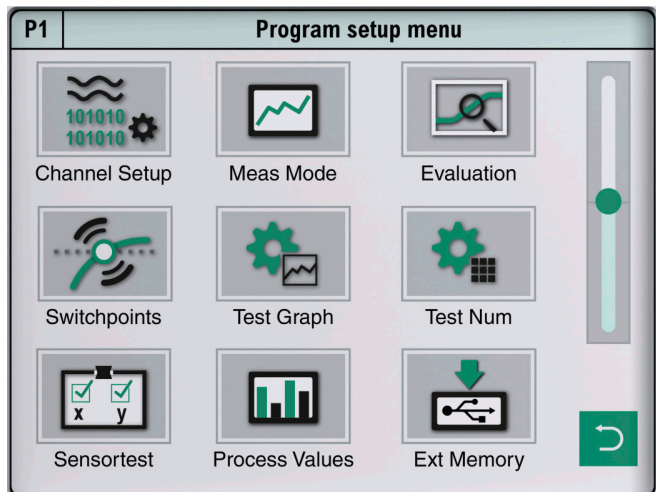

Figure: Parameterization level  
Measurement program configuration

**Logging data on USB flash drive**

A USB flash drive can be plugged into the rear USB port (type A) for local logging of measurement data. This form of data logging can be custom-configured for each measurement program. At the end of the measurement cycle and the internal evaluation in the DIGIFORCE® 9311, a data-log entry is then written into the available \*.csv-file in a time period of less than 250 msec. The log file contains a header that includes general data such as component name and batch ID, and a new line entry for each measurement, which includes the following data:

- ▶ Date / Time
- ▶ Overall result OK/NOK
- ▶ Serial number (SN from order sheet)
- ▶ Part counter
- ▶ “General curve data” dataset (2x7 floating point values)
- ▶ “User-defined values” dataset (up to 20 floating point values)

**burster TEDS**

DIGIFORCE® 9311 uses the burster TEDS (Transducer Electronic Data Sheet) to provide automatic sensor recognition, i.e. the instrument reads the relevant sensor specification from an EEPROM, fitted in the sensor connector, and then uses this data to perform the necessary channel configuration automatically. The memory chip in the sensor connector is programmed as part of a service provided when the sensor is first ordered or subsequently calibrated. The burster TEDS feature is only available for sensors that have a permanently fitted connecting lead.

\* is omitted in the version V2xxx

### Curve analysis (Viewer - version V0xxx with display only)

You can use the "Viewer" tool to look at the most recent 50 measurement curves either as individual curves or as a curve array. In addition, you have detailed numeric data available for each measurement, such as individual results from the graphical evaluation elements and the associated window entry and exit coordinates. If you are getting occasional NOK measurements, you can then use this tool to look at the measurement curve even after the test, and take suitable corrective action to prevent NOK parts. The DigiControl PC software can be used to retrieve and analyse these sets of curves.

### Panel mounting

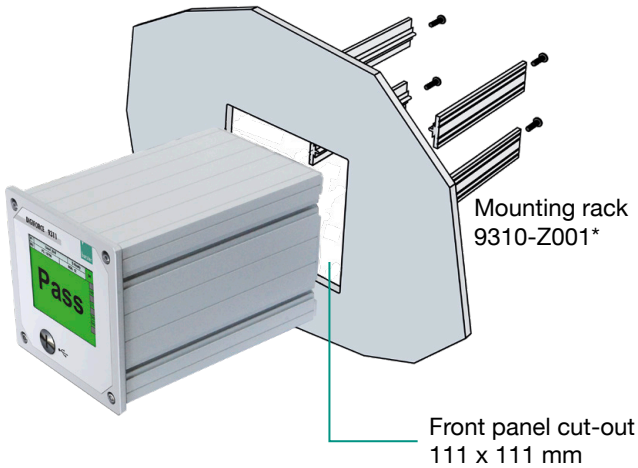

\* not suitable for the version V2xxx

### PC software DigiControl

The **BASIC version**, which is available free of charge, supports full device configuration, creation of backups, and retrieval and display of measurement curves, including all evaluation results and statistics. An especially convenient feature is the definition of graphical evaluation elements such as envelopes, windows, trapeziums and thresholds based on a set of curves of measured master or reference parts. Alternatively, ready-archived measurements can also be used to create new evaluations. The **PLUS version** (9311-P100) of the PC software DigiControl provides, in addition to the standard functions, an automatic production mode, which, for example, logs production measurement data with clear parts references. The resultant measurement logs are not only available in the internal program format, but can also be imported into EXCEL data. Even for

### Cabinet version (V2xxx)

The cabinet module (V2xxx) is designed for snap-rail mounting according to DIN EN 50222. This version is running with 24 VDC supply voltage. Status information including evaluation results is provided by a set of monitoring LEDs. The V2xxx module can be fully configured and parameterized using the DigiControl PC-Software. The optional fieldbus interfaces like PROFINET also offers access to the configuration parameters. DIGIFORCE® 9311 cabinet module (V2xxx) includes all the standard performance features like the display version does. Networking can take place in parallel via fieldbus interface to the PLC (switch function with PROFINET and EtherNet/IP available) and via standard Ethernet to a host system. It is mainly designed for multi-channel solutions with several units and additional DigiControl human interface.

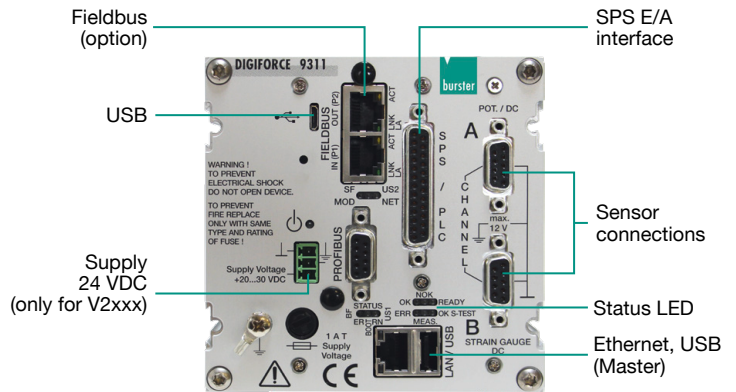

Figure: DIGIFORCE® 9311 cabinet version (V2xxx)

synchronous processes involving large amounts of data, logging of measurement data is optimized to achieve an ultra-short cycle time. In addition, the software supports an extra remote interface for more complex tasks. This can be used, for instance, for reloading device configurations or transferring component references for measurement data logging.

### Porting from DIGIFORCE® 9310 to DIGIFORCE® 9311

A DIGIFORCE® 9311 device configuration can be generated from a DIGIFORCE® 9310 backup file using DigiControl. The software imports the sensor and evaluation settings and selects as close a configuration as possible for the DIGIFORCE® 9311.

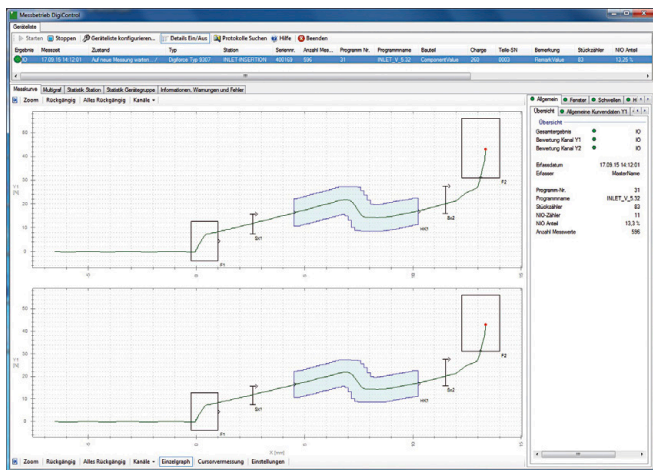

Figure: The „measurement mode“ function displays the curve and status information of the most recent measurement. A multi-channel view is also possible. The corresponding log is automatically saved in the background.

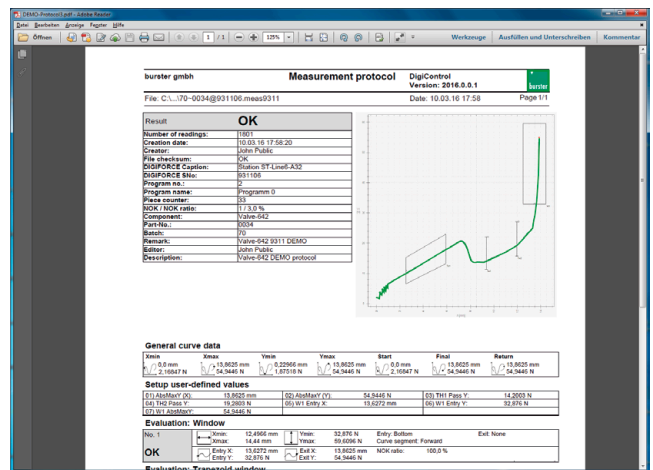

Figure: A Data-log wizard provides filters for selecting and displaying stored measurement logs. A log printout containing component data, curve information and all evaluation results can be generated for each individual measurement log.

9311 EN

## General Technical Data

Sampling rate:	10 kHz
Signal sampling:	$\Delta X, \Delta Y, \Delta t$ in any combination
Digitalization:	16 bit
Evaluation time:	typ. 25 ms
Measurement programs:	16
Power supply:	
Desktop/panel version V0xxx:	100 ... 240 VAC $\pm 10\%$ , 50 ... 60 Hz $\pm 10\%$
Cabinet mounted version V2xxx:	20 ... 30 VDC
Power consumption:	< 15 VA
Delay in real-time limit signals S1 ... S6:	typ. $\leq 3$ ms
Operating temperature range:	+ 5 ... + 23 ... + 40°C
Protection class:	
Desktop/panel version V0xxx:	IP40 / IP65 panel mounted
Cabinet mounted version V2xxx:	IP20
Display*:	3.5" TFT colour LCD (320 x 240)
Operation*:	touch operation
Operating language*:	German, English, French, Italian, Spanish, Chinese (only process window)

\* is omitted in the version V2xxx

## Compatible Sensors

Flexible assignment of physical channels A ... B to measurement graphs (X/Y coordinates). The function burster TEDS is not available at the optional piezo channel.

### Channel A (potentiometer, process signals)

Excitation voltage:	5 V
Excitation current:	10 mA max.
Signal range:	$\pm 5$ V, $\pm 10$ V
Cut-off frequency:	5 ... 5000 Hz in discrete bands
Total error:	< 0.2 % F.S.

### Channel B (strain gauge, process signals)

#### Strain gauge sensors

Measurement ranges:	2/4/10/20/40 mV/V
Bridge resistance:	120 $\Omega$ ... 5 k $\Omega$
Excitation voltage:	5 V
Excitation current:	30 mA max.
Cut-off frequency:	5 ... 5000 Hz in discrete bands
Total error:	< 0.2 % F.S.

#### Process signals

Measurement ranges:	$\pm 5$ V, $\pm 10$ V
Cut-off frequency:	5 ... 5000 Hz in discrete bands
Total error:	< 0.2 % F.S.

### Channel B Piezoelectric (option)

Measurement ranges:	1 nC ... 1 $\mu$ C in discrete bands
Cut-off frequency:	5 ... 5000 Hz in discrete bands
Total error:	< 1 % F.S.

This option replaces the channel for strain gauge and process signals.

### Transmitter excitation für X and Y channel

only for cabinet version V2xxx: 20 ... 30 VDC / 150 mA

## I/O and Fieldbus Interfaces

### I/O interface

Parallel PLC port according to EN 61131-2, 24 VDC, opto-isolated, positive logic  
 10 inputs, of which 3 are configurable  
 13 outputs, of which 6 are configurable, maximum load  $I_{MAX}$  500 mA,  $I_{MAX TOTAL}$  800 mA (all outputs)  
 D-SUB-25 (model female)

### PROFIBUS (option)

D-SUB9  
 Baud rate max. 12 MBaud  
 Communication protocol cyclic service **DP-V0**  
 acyclic service **DP-V1**

### PROFINET, EtherNet/IP, EtherCAT (option)

2 port western-socket (RJ45)  
 Communication protocol cyclical realtime process data  
 acyclic parameter data

## Communication Interfaces

Device parameterization, data backup (up/download), high-speed measurement data logging, USB data logging

USB	Slave port (Micro-B)
	Front panel
	Data rate ~ 1 MBaud

Technical changes reserved. All data sheets at [www.burster.com](http://www.burster.com)

USB	Master port (type A) Rear side USB data logging Data format FAT16/32, max. 32 GB 10/100 MBit, western-socket (RJ45)
Ethernet	At the cabinet mounted version V2xxx all connectors are placed at the front side.

## Housing

Combined desktop/panel-mounted housing (W x H x D):	110 x 110 x 183 [mm]
Desktop version:	4 rubberized feet (fitted as standard)
Front panel (W x H):	119 x 119 [mm]
Front panel cut-out (W x H):	111 x 111 [mm]
Weight:	ca. 1.5 kg
Panel mounting:	rubber feet are replaced by the mounting rack (order code 9310-Z001), device is inserted through the front-panel cut-off and is fixed by screws (see page 5).
Cabinet mounted version V2xxx:	for rail mounting (mounting rail to DIN EN 50022)

## Accessories

Fixing kit for panel mounting	<b>Model 9310-Z001*</b>
Connection outlines for mounting several DIGIFORCE® 9311 (2 outlines, 4 screws)	<b>Model 9310-Z002*</b>

\* not suitable for the version V2xxx

## PC software

DigiControl PC software BASIC version for convenient device configuration including backup function (upload/download), laboratory mode for manual reading and analysis of measurement curves, and data-log wizard with print and export functions; available free of charge from [www.burster.com](http://www.burster.com)

DigiControl PC software PLUS version including high-speed, in process logging of measurement data, Data-log wizard, ASCII raw data, EXCEL, PDF and SQL export  
**Model 9311-P100**

## Cable and connectors

Connecting cable for burster displacement sensors 8710 ... 8719 series, length 3 m	<b>Model 99209-591A-0090030</b>
Extension cable for sensors with 9900-V209 plug, length 3 m	<b>Model 99209-609A-0150030</b>
Bridging cable for routing the displacement sensor signal from DIGIFORCE® 9311 to a following device, length 0.5 m	<b>Model 9900-K340</b>
USB data cable for front-side service interface, length 2 m	<b>Model 9900-K358</b>
Connecting plug for A, B channel (strain gauge, process signals, potentiometer)	<b>Model 9900-V209</b>
Connecting plug for PLC-I/O port, 25 pin, Min-D	<b>Model 9900-V160</b>
USB data cable for front service interface, length 2 m	<b>Model 9900-K358</b>

## burster TEDS

Connector 9 pin, Min-D incl. memory chip for the electronic sensor data sheet  
**Model 9900-V229**

Fitting connector of the connecting plug incl. programming the electronic sensor data sheet  
**99011**

## Adjustment of a complete measuring chain

Adjustment and scaling of channel X and Y including test certificate  
**93ABG**

## Order Code

<b>DIGIFORCE®</b>	<b>9311 - V</b>	<input type="checkbox"/>	<input type="checkbox"/>	<input type="checkbox"/>	<input type="checkbox"/>
<b>Standard</b> display version (AC supply)		0	0	0	0
<b>Standard</b> cabinet mounted version (DC supply)		2	0	0	0
<b>Option card analog</b> Piezo (instead of strain gauge, process signals)			1		
<b>Fieldbus</b>					
EtherCAT					1
PROFIBUS (DP-V0/DP-V1)					2
PROFINET					3
EtherNet/IP					4

## Warranty extension

Warranty extension to 36 months instead of 24 months  
**9311-WARRANTY-36M**

burster praezisionsmesstechnik gmbh & co kg Germany  
 Talsir. 1-5 · Gernsbach 76593 · Phone +49-7224-6450  
[www.burster.com](http://www.burster.com)  
[info@burster.com](mailto:info@burster.com)