

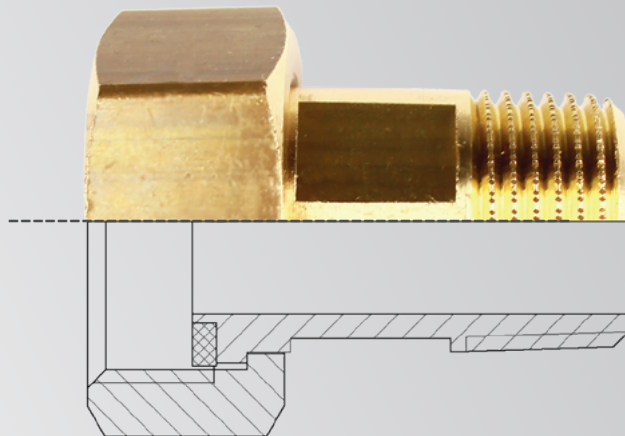

# Water Meter Fittings.

Accessories for  
Water Meter Installation Sets.































■ made  
■ in  
■ Germany

G

**STAY**

**CONNECTED.**

Image	Description	Page	Image	Description	Page	Image	Description	Page
	Water meter fitting Model 6801 ● ●	4		Extension piece Model 6842 ● ●	7		Blocking disc (plastic) Model 60202 ●	9
	Water meter fitting Model 6801V ● ●	4		Connector Model 6843 ● ●	7		Seal (HDPE) (for connector model 6843) Model 6843.1 ● ●	10
	Water meter fitting chromed Model 6801V ● ●	4		Connector Model 6844 ● ●	7		Seal (HDPE) Model 6092 ● ●	10
	Water meter fitting, reduced Model 6820 ● ●	4		Reduction connector Model 6845 ● ●	7		HW-seal Model 6093 ● ●	10
	Water meter fitting, with drain connection Model 6810 ● ●	5		Water meter test adapter/ flushing adapter Model 60200 ● ●	8		Sealing device Model 6091	10
	Water meter fitting, with sealing surface and bore Model 68011 ● ●	5		Bridging pipe Model 60050 ● ●	8		Wrench set Model 6097	11
	Water meter fitting, reduced with bore Model 68201 ● ●	5		Bridging pipe Model 60171 ●	8		Installation set for water meter installation set Model 6070E	11
	Socket Model 166 ● ●	6		S-bend Model 6050 ● ●	9		Noise isolating plugs Model 6071	11
	Socket Model 167 ● ●	6		Sliding sleeve with non-return valve Model 6094 ● ●	9		Spare parts for water meter installation sets (even for previous models, e.g. B 60 NW 1 1/2" and Lugi KIII) ● ●	12/13
	Extension fitting Model 6840 ● ●	6		Blocking disc (brass) Model 60200.1 ● ●	9			

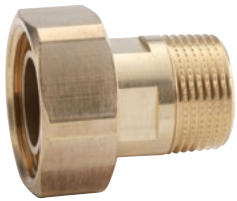

**WATER METER FITTING**  
**Model 6801**

with sealing surface, without bore  
incl. seal

Item may differ from the picture.

dimension female x male thread	D	W	pkg. unit	EAN no. 4027848-
3/4" x 1/2"	●	●	25	143184
1" x 3/4"	●	●	25	143191
1" x 3/4" (light model)	●	●	25	143696
1 1/4" x 1"	●	●	10	143207
1 1/2" x 1 1/4"	●	●	1	143214
2" x 1 1/2"	●	●	1	143221
2 1/2" x 2"	●	●	1	143238



**WATER METER FITTING**  
**Model 6801V**

without sealing surface, without bore

Item may differ from the picture.

dimension female x male thread	D	W	pkg. unit	EAN no. 4027848-
3/4" x 1/2"	●	●	25	177332
1" x 3/4"	●	●	25	177356
1 1/4" x 1"	●	●	10	177370
1 1/2" x 1 1/4"	●	●	1	177394



**WATER METER FITTING**  
**Model 6801V**

chromed  
with sealing surface, without bore  
incl. seal

Item may differ from the picture.

dimension female x male thread	D	W	pkg. unit	EAN no. 4027848-
3/4" x 1/2"	●	●	25	185351
1" x 3/4"	●	●	25	185368



**WATER METER FITTING**  
**Model 6820**

reduced, with sealing surface, without bore  
incl. seal

Item may differ from the picture.

dimension female x male thread	D	W	pkg. unit	EAN no. 4027848-
1" x 1/2"	●	●	5	143245

APPLICATION	D	● = Drinking water
	W	● = Water



**WATER METER FITTING**  
**Model 6810**

with drain connection 1/4", with sealing surface, without bore  
incl. seal

Item may differ from the picture.

dimension female x male thread	D	W	pkg. unit	EAN no. 4027848-
3/4" x 1/2"	●	●	5	143368
1" x 3/4"	●	●	5	143375
1 1/4" x 1"	●	●	5	143382
1 1/2" x 1 1/4"	●	●	5	143399
2" x 1 1/2"	●	●	1	343058

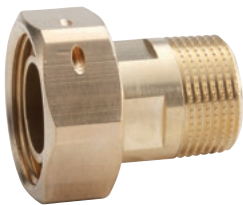

**WATER METER FITTING**  
**Model 68011**

with sealing surface and bore  
incl. seal

Item may differ from the picture.

dimension female x male thread	D	W	pkg. unit	EAN no. 4027848-
3/4" x 1/2"	●	●	25	143276
1" x 3/4"	●	●	10	143283
1" x 3/4" (light model)	●	●	25	143702
1 1/4" x 1"	●	●	10	143290
1 1/2" x 1 1/4"	●	●	5	143306
2" x 1 1/2"	●	●	1	143313
2 1/2" x 2"	●	●	1	143320



**WATER METER FITTING**  
**Model 68201**

reduced, with sealing surface and bore  
incl. seal

Item may differ from the picture.

dimension female x male thread	D	W	pkg. unit	EAN no. 4027848-
1" x 1/2"	●	●	5	143337
1 1/4" x 3/4"	●	●	5	143344



**SOCKET**  
**Model 166**

with copper female soldering end, without sealing surface, flat sealing

Item may differ from the picture.

dimension female x male thread	dimension copper pipe $\phi$	NW	D	W	pkg. unit	EAN no. 4027848-
3/4"	15	1/2"	●	●	20	201099
3/4"	18	1/2"	●	●	20	197941
1"	22	3/4"	●	●	20	195251
1 1/4"	28	1"	●	●	10	191390
1 1/2"	35	1 1/4"	●	●	5	193660
2"	42	1 1/2"	●	●	1	192243
2 1/2"	54	2"	●	●	1	192250



**SOCKET**  
**Model 167**

with copper female soldering end, without sealing surface and bore incl. seal

Item may differ from the picture.

dimension female x male thread	dimension copper pipe $\phi$	NW	D	W	pkg. unit	EAN no. 4027848-
3/4"	15	1/2"	●	●	10	143566
3/4"	18	1/2"	●	●	10	143573
1"	22	3/4"	●	●	10	143580
1 1/4"	28	1"	●	●	10	143597
1 1/2"	35	1 1/4"	●	●	5	143603
2"	42	1 1/2"	●	●	2	143610
2 1/2"	54	2"	●	●	1	143627

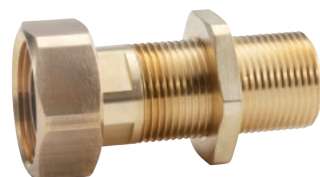

**SOCKET**  
**Model 6840**

with Cu internal soldering end, without sealing surface and bore incl. seal

Item may differ from the picture.

dimension female x male thread	D	W	pkg. unit	EAN no. 4027848-
3/4" x 1/2"	●	●	10	143634
1" x 3/4"	●	●	10	143641
1 1/4" x 1"	●	●	5	143658
1 1/2" x 1 1/4"	●	●	2	143665
2" x 1 1/2"	●	●	1	143672

APPLICATION	D	● = Drinking water
	W	● = Water



### EXTENSION PIECE

Model 6842

without seal

(suitable seals:

for version 1":  $\varnothing 30 \times \varnothing 23 \times 2$  mm - model 6092 and 6093 see page 10

for version 1 1/4":  $\varnothing 38 \times \varnothing 29 \times 2$  mm - model 6092 and 6093 see page 10)

Item may differ from the picture.

thread	length compensation	D	W	pkg. unit	EAN no. 4027848-
1" x 1"	28 mm	●	●	25	143146
1 1/4" x 1 1/4"	30 mm	●	●	5	143153



### CONNECTOR

Model 6843

35 mm length compensation from 260 mm up to 190 mm

for reduction from Qn 6 (new:  $Q_3 = 10$ ) to Qn 2,5 (new:  $Q_3 = 4$ )

without seal

(suitable seal:  $\varnothing 30 \times \varnothing 21 \times 2$  mm - model 6843.1 see page 10)

Item may differ from the picture.

thread female x male	length compensation	reduction	D	W	pkg. unit	EAN no. 4027848-
1" x 1 1/4"	35 mm	from Qn 6 to Qn 2,5	●	●	10	143160



### CONNECTOR

Model 6844

20 mm length compensation from 300 mm up to 260 mm

for reduction from Qn 10 (new:  $Q_3 = 16$ ) to Qn 6 (new:  $Q_3 = 10$ )

without seal

(suitable seal:  $\varnothing 38 \times \varnothing 29 \times 2$  mm - model 6092 or 6093 see page 10)

Item may differ from the picture.

thread female x male	length compensation	reduction	D	W	pkg. unit	EAN no. 4027848-
1 1/4" x 2"	20 mm	from Qn 10 to Qn 6	●	●	5	143177



### REDUCTION CONNECTOR

Model 6845

incl. flexible union nut and seal

for reduction from Qn 6 (new:  $Q_3 = 10$ ) to Qn 2,5 (new:  $Q_3 = 4$ ) or

for reduction from Qn 10 (new:  $Q_3 = 16$ ) to Qn 2,5 (new:  $Q_3 = 4$ )

Item may differ from the picture.

thread female x male	length compensation	reduction	D	W	pkg. unit	EAN no. 4027848-
1" x 1 1/4"	35 mm	from Qn 6 to Qn 2,5	●	●	10	352180
1" x 2"	55 mm	from Qn 10 to Qn 2,5	●	●	10	352326

**WATER METER TEST ADAPTER/ FLUSHING ADAPTER**

**Model 60200**



made of brass

for horizontal water meter installation sets and house connection conduits, applicable for e.g. site water extraction or the connection of a test pump, middle outlet with female or male thread, optional: one side without passage

Item may differ from the picture.

suitable for NW	passage	length (mm)	middle outlet	D	W	pkg. unit	EAN no. 4027848-
3/4"	1" male thread	190	3/4" female	●	●	1	231447
3/4"	1" male thread	190	1" female	●	●	1	237302
3/4"	1" male thread	190	1" male	●	●	1	236633

**BRIDGING PIPE**

**Model 60050**



made of brass

Item may differ from the picture.

suitable for NW	suitable for	length (mm)	male thread	D	W	pkg. unit	EAN no. 4027848-
1/2"	riser	105	3/4"	●	●	10	153565
1/2"	horizontal	165	3/4"	●	●	10	153558
3/4"	riser	105	1"	●	●	10	153589
3/4"	horizontal	190	1"	●	●	5	153572
1"	horizontal	260	1 1/4"	●	●	2	153596

**BRIDGING PIPE**

**Model 60171**



made of plastic  
(only for temporary installation)

Item may differ from the picture.

suitable for NW	suitable for	length (mm)	male thread	D	W	pkg. unit	EAN no. 4027848-
3/4"	horizontal	190	1"		●	10	153718
1"	horizontal	260	1 1/4"		●	10	153725



APPLICATION	D	● = Drinking water
	W	● = Water



**S-BEND**  
Model 6050

with cylindrical female thread and conical male thread

Item may differ from the picture.

thread	offset (mm)	D	W	pkg. unit	EAN no. 4027848-
1"	45	●	●	5	142699
1 1/4"	50	●	●	5	142705



**SLIDING SLEEVE**  
Model 6094

with non-return valve

Item may differ from the picture.

for water meter NW	D	W	pkg. unit	EAN no. 4027848-
3/4"	●	●	5	153879



**MESSING-SPERRSCHEIBE**  
Model 60200.1

closed, without bore  
among others applicable for water meter test adapter/ flushing adapter model 60200 and also for water meter installation sets Q<sub>3</sub> = 4 (before Qn 2,5)

Item may differ from the picture.

dimension	D	W	pkg. unit	EAN no. 4027848-
30 x 2	●	●	1	233700



**PLASTIC BLOCKING DISC**  
Model 60202

with center bore (0,6 mm) for water meter installation sets Q<sub>3</sub> = 4 (before Qn 2,5)

Item may differ from the picture.

dimension	D	W	pkg. unit	EAN no. 4027848-
30 x 3		●	1	273911



**SEAL (HDPE)**

**Model 6843.1**

resistant up to max. 40 °C (not for gas),  
for connector item no. 143160 - model 6843

Item may differ from the picture.

dimension	D	W	pkg. unit	EAN no. 4027848-
30 x 21 x 2	●	●	50	242009



**SEAL (HDPE)**

**Model 6092**

resistant up to max. 40 °C (not for gas)

Item may differ from the picture.

for NW	dimension (mm)	D	W	pkg. unit	EAN no. 4027848-
1/2"	23,5 x 16,5 x 2	●	●	25	183685
3/4"	30 x 23 x 2	●	●	25	183692
1"	38 x 29 x 2	●	●	25	325221
1 1/4"	44 x 35 x 2	●	●	50	183715
1 1/2"	55 x 43 x 2	●	●	50	183739
2"	72 x 60 x 2	●	●	50	183746



**HW SEAL**

**Model 6093**

made of vulcanized fiber, resistant up to max. 90 °C (not for gas)

Item may differ from the picture.

for NW	dimension (mm)	D	W	pkg. unit	EAN no. 4027848-
1/2"	23,5 x 16,5 x 2	●	●	50	183555
3/4"	30 x 23 x 2	●	●	50	183579
1"	38 x 29 x 2	●	●	50	183593
1 1/4"	44 x 35 x 2	●	●	20	183616
1 1/2"	55 x 43 x 2	●	●	10	183647



**SEALING DEVICE**

**Model 6091**

white, adjustable

Item may differ from the picture.

for union nut	pkg. unit	EAN no. 4027848-
1" - 2 1/4"	200	183265

APPLICATION	D	● = Drinking water
	W	● = Water



### WRENCH SET

Model 6097

consisting of:  
 double open-end wrench (opening 24/38) hardened and burnished (extremely flat) for water meter installation set and  
 socket wrench (hexagon) (opening 38) for counter nut

Item may differ from the picture.

	pkg. unit	EAN no. 4027848-
for water meter installation sets $Q_3 = 4$ (before Qn 2,5)	1	322534

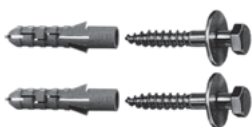

### MOUNTING SET

Model 6070E

for water meter installation sets, for cold water up to max 40 °C (not for gas)

consisting of: 2 screws made of stainless steel, 2 washers made of stainless steel, 2 plugs made of plastic, 2 HDPE seals

Item may differ from the picture.

for water meters	pkg. unit	EAN no. 4027848-
$Q_3 = 2,5$ (before Qn 1,5)	1	266036
$Q_3 = 4$ (before Qn 2,5)	1	266043
$Q_3 = 10$ (before Qn = 6)	1	266050
$Q_3 = 16$ (before Qn 10)	1	266067



### NOISE ISOLATING PLUGS

Model 6071

noise isolating  
 (for the acoustic decoupling of water meter installation sets)  
 packed in pairs

Item may differ from the picture.

for mounting set model 6070E	pkg. unit	EAN no. 4027848-
up to $Q_3 = 10$ (before Qn 6)	1	153763

**LAF B 61**

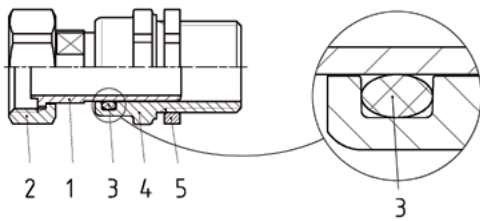

- 1 sliding sleeve
- 2 union nut
- 3 o-ring chambered
- 4 housing
- 5 counter nut

**LAF B 60**

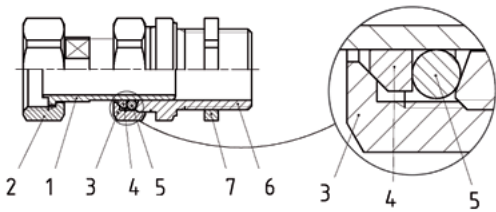

- 1 sliding sleeve
- 2 union nut
- 3 forcing nut
- 4 forcing ring
- 5 o-ring
- 6 housing
- 7 counter nut

The following table shows the mostly required spare parts. Further parts on request.

for water meter installation sets	description	dimension	D	W	pkg. unit	EAN no. 4027848-
Qn 1,5 (new Q <sub>3</sub> = 2,5) with LAF B 61	sliding sleeve with sealing surface	1/2" x 47	●	●	1	209576
	o-ring (EPDM for hot water up to 130°C)	20 x 4	●	●	1	210213
Qn 2,5 (new Q <sub>3</sub> = 4) with LAF B 61	sliding sleeve with sealing surface	3/4" x 54,5	●	●	1	180332
	o-ring (EPDM for hot water up to 130°C)	25 x 4	●	●	1	338672
Qn 2,5 (new Q <sub>3</sub> = 4) with LAF B 60	sliding sleeve with sealing surface	3/4" x 54,5	●	●	1	180332
	forcing nut	M 35 x 1,5	●	●	1	180349
	forcing ring	32 x 25 x 3	●	●	1	180356
	o-ring (EPDM for hot water up to 130°C)	25 x 4	●	●	1	338672
Qn 6 (new Q <sub>3</sub> = 10) with LAF B 60	sliding sleeve with sealing surface	1" x 58,5	●	●	1	180486
	forcing nut	M 42 x 1,5	●	●	1	180509
	forcing ring	38,9 x 32 x 3	●	●	1	180493
	o-ring (EPDM for hot water up to 130°C)	32 x 4	●	●	1	338634
Qn 10 (new Q <sub>3</sub> = 16) with LAF B 60	sliding sleeve with sealing surface	1 1/2" x 70	●	●	1	203666
	forcing nut	M 60 x 1,5	●	●	1	180622
	forcing ring	55,5 x 47,6 x 3	●	●	1	180639
	seal	49 x 40 x 8	●	●	1	192410

APPLICATION	D	● = Drinking water
	W	● = Water

### LAF B 60

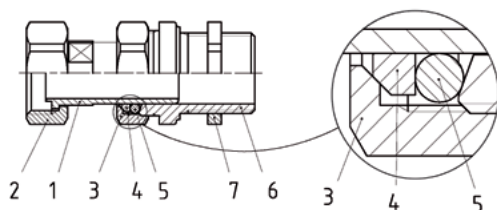

- 1 sliding sleeve
- 2 union nut
- 3 forcing nut
- 4 forcing ring
- 5 o-ring
- 6 housing
- 7 counter nut

For the former water meter installation sets **model B60 NW 1 1/2"** and **Lugi KIII** we still have the following spare parts in stock:

for LAF	description	dimension	D	W	pkg. unit	EAN no. 4027848-
Qn 1,5 (new Q <sub>3</sub> = 2,5)	counter nut	3/4"	●	●	1	209774
	forcing nut	3/4"	●	●	1	209781
	union nut	3/4"	●	●	1	209811
	seal	24 x 18 x 5	●	●	1	209873
	forcing ring		●	●	1	209798
Qn 2,5 (new Q <sub>3</sub> = 4)	counter nut	1"	●	●	1	142385
	counter nut	1 1/4"	●	●	1	153008
	forcing nut	1"	●	●	1	152537
	sliding sleeve	3/4" - 71,5	●	●	1	152544
	union nut	1"	●	●	1	177349
	seal	30 x 24 x 5	●	●	1	152568
forcing ring (plastic)	30 x 24,7 x 4	●	●	1	152575	
Qn 6 (new Q <sub>3</sub> = 10)	counter nut	1 1/4"	●	●	1	153008
	counter nut	1 1/2"	●	●	1	153015
	forcing nut	1 1/4"	●	●	1	153169
	sliding sleeve	1" - 66	●	●	1	153183
	seal	37 x 28,5 x 5	●	●	1	153220
	forcing ring (plastic)	38 x 31 x 4	●	●	1	153244
Qn 10 (new Q <sub>3</sub> = 16)	counter nut	2"	●	●	1	142415
	forcing nut	M 60 x 1,5	●	●	1	180622
	sliding sleeve	1 1/2" - 70	●	●	1	203666
	union nut	2"	●	●	1	177400
	seal	49 x 42 x 8	●	●	1	195114
	forcing ring (plastic)	55,5 x 47,6 x 3	●	●	1	180639

# Notes

