

High-Precision Torque Sensor for non-rotating applications

MODEL 8625



NEW
immune to side loads
thanks to support bearings



8625 with flange

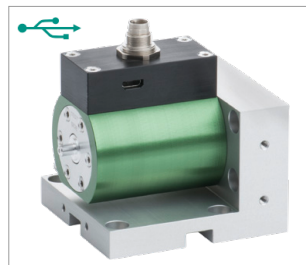

8625 with bracket

Highlights

- Measurement ranges of 0 ... 0.01 N·m to 0 ... 200 N·m
- Linearity error as low as from ≤ 0.05 % F.S.
- Standardized output signal
- Tare function, filter and average values configurable

Options

- Output signal ± 10 V / USB
- burster TEDS
- Bracket or flange adapter offers choice of mounting options
- Immune to side loads thanks to built-in support bearings
- Dual-range model

Applications

- Test setups for precision mechanics
- Measuring the frictional torque of bearings
- Measuring the torques applied to vehicle control elements and knobs
- Reference sensor in calibration systems

Product description

This high precision torque sensor is designed for both static and dynamic measurements on non-rotating applications. It is particularly suitable for torque measurements on, for instance, extremely small electrical actuating drives and micro-mechanical actuator elements, or for measuring reaction torques e.g. on micro-motors.

The high accuracy of measurement also makes this sensor ideal for use as a reference in many fields of industrial manufacture as well as laboratory research and development projects. Not containing any rotating parts, it requires no maintenance if properly used.

The strain-gage based sensor's modular design allows precise configuration for the desired application. With the integrated amplifier option, the sensor directly supplies a voltage signal of 0 ... ± 10 V that is proportional to the torque. The sensor can be configured via the micro-USB interface, providing access to, for example, a filter frequency setting, averaging, and a tare function. Measurements via USB in addition to the voltage output are available with the USB measurement option. The sensor comes with the DigiVision software for performing measurements and data archiving, with drivers additionally available e.g. for LabVIEW. Integration into custom software is possible via DLL.

The burster TEDS option (electronic data sheet, memory chip with sensor-specific data) allows rapid configuration of compatible evaluation units (instrumentation amplifier, indicator, ...).

Technical Data

8625	-	4010-VXXXXX	4020-VXXXXX	4050-VXXXXX	4100-VXXXXX	4200-VXXXXX	4500-VXXXXX	5001-VXXXXX
Measuring range calibrated in N·m from 0 ...		±0.01 N·m	±0.02 N·m	±0.05 N·m	±0.1 N·m	±0.2 N·m	±0.5 N·m	±1 N·m
Accuracy								
Relative non-linearity		0.15 % F.S.	0.1 % F.S.		0.05 % F.S.			
Relative hysteresis		0.15 % F.S.	0.1 % F.S.					
Tolerance of sensitivity		0.2 % F.S.	0.1 % F.S.					
Maximum limit axial load	[N]	50						
Maximum limit radial load	[N]	1			1.5		2	3
Spring constant	[N·m/rad]	5	8	10	18	41	115	261
Mass moment of inertia measuring side	[10 ⁻⁶ kg·m ²]	0.022	0.026	0.059	0.749	0.812	0.886	1.15
Electrical values without amplifier								
Sensitivity		0.25 mV/V			0.5 mV/V			
Bridge resistance (full bridge)		1000 Ω						
Excitation voltage		5 V (max. 10 V)						
Environmental conditions without amplifier								
Range of operating and nominal temperature		-20 °C ... +80 °C						
Sensitivity of temperature effects		on the zero point 0.020 % F.S./K on the sensitivity 0.015 % F.S./K			0.015 % F.S./K 0.010 % F.S./K			
Electrical values with amplifier/USB								
Rated supply voltage range		5 ... 30 V DC (or 5 V via USB)						
DC power consumption		approx. 1 W						
Output voltage at ± rated torque		±10 V						
Output resistance		< 500 Ω						
Insulation resistance		zero (binding capability)						
-3 dB cut-off frequency		5000 Hz						
Ripple		<50 mV _{ss}						
Control signal		10.00 V DC						
Environmental conditions with amplifier/USB								
Range of operating and nominal temperature		0 °C ... +60 °C						
Sensitivity of temperature effects		on the zero point 0.020 % F.S./K on the sensitivity 0.015 % F.S./K			0.015 % F.S./K 0.010 % F.S./K			
Mechanical values								
Dynamic overload safe		recommended 70 % of nominal torque						
Max. operation torque		150 % of nominal torque (≥ 0.2 N·m)						
Breakaway torque		300 % of nominal torque						
Alternating load		70 % of nominal torque						
Other								
Material		Housing: made of anodized aluminium Shaft: high-strength aluminium 3.1354			Shaft: steel shell 1.4542			
Protection class		acc. EN 60529, IP40						
Weight	[g]	150			180		190	
Geometry								
L	[mm]	59		65		85		
LJ	[mm]	48						
H	[mm]	47						
H1	[mm]	32						
∅ J	[mm]	40						
D	[mm]	4g6		6g6		8h6		
LK	[mm]	20						
A/B	[mm]	5.5		8		18		
G	[mm]	M4						
Installation								
Installation instructions		Do not exceed the permitted axial and radial forces during fitting and operation. Please refer to our operating instructions for detailed information (www.burster.com). Do not use the housing as a means of absorbing torque.						

Technical Data

8625	-	5002-VXXXXX	5005-VXXXXX	5010-VXXXXX	5020-VXXXXX	5050-VXXXXX	5100-VXXXXX	5200-VXXXXX
Measuring range calibrated in N·m from 0 ...		±2 N·m	±5 N·m	±10 N·m	±20 N·m	±50 N·m	±100 N·m	±200 N·m
Accuracy								
Relative non-linearity		0,05 % F.S.						
Relative hysteresis		0,1 % F.S.						
Tolerance of sensitivity		0,1 % F.S.						
Maximum limit axial load	[N]	50	200		1500	3000	4000	8000
Maximum limit radial load	[N]	6	15	30	40	80	150	275
Spring constant	[N·m/rad]	304	1242	2604	5500	13000	28000	61000
Mass moment of inertia measuring side	[10 ⁻⁶ kg·m ²]	1.17	1.44	2.2	22	24	123	139
Electrical values without amplifier								
Sensitivity		1 mV/V						
Bridge resistance (full bridge)		1000 Ω						
Excitation voltage		5 V (max. 10 V)						
Environmental conditions without amplifier								
Range of operating and nominal temperature		-20 °C ... +80 °C						
Sensitivity of temperature effects		on the zero point 0.015 % F.S./K on the sensitivity 0.01 % F.S./K						
Electrical values with amplifier/USB								
Rated supply voltage range		5 ... 30 V DC (or 5 V via USB)						
DC power consumption		approx. 1 W						
Output voltage at ± rated torque		±10 V						
Output resistance		< 500 Ω						
Insulation resistance		zero (binding capability)						
-3 dB cut-off frequency		5000 Hz						
Ripple		<50 mV _{ss}						
Control signal		10.00 V DC						
Environmental conditions with amplifier/USB								
Range of operating and nominal temperature		0 °C ... +60 °C						
Sensitivity of temperature effects		on the zero point 0.015 % F.S./K on the sensitivity 0.010 % F.S./K						
Mechanical values								
Dynamic overload safe		70 % of nominal torque						
Max. operation torque		150 % of nominal torque						
Breakaway torque		300 % of nominal torque						
Alternating load		70 % of nominal torque						
Other								
Material		Housing: made of anodized aluminium; Shaft steel shell 1.4542						
Protection class		acc. EN 60529, IP40						
Weight	[g]	190	480	495	1100	1140		
Geometry								
L	[mm]	85			103		136	
LJ	[mm]	48			55		65	
H	[mm]	47			63		79	
H1	[mm]	32			48		64	
∅ J	[mm]	40			55		70	
D	[mm]	8h6	10h6		15g6		26g6	
LK	[mm]	20			26		41	
A/B	[mm]	18			24		35,5	
G	[mm]	M4			M6		M8	
Installation								
Installation instructions		Do not exceed the permitted axial and radial forces during fitting and operation. Please refer to our operating instructions for detailed information (www.burster.com). Do not use the housing as a means of absorbing torque.						

Dimensional drawing - measuring ranges 0.01 Nm ... 10 Nm

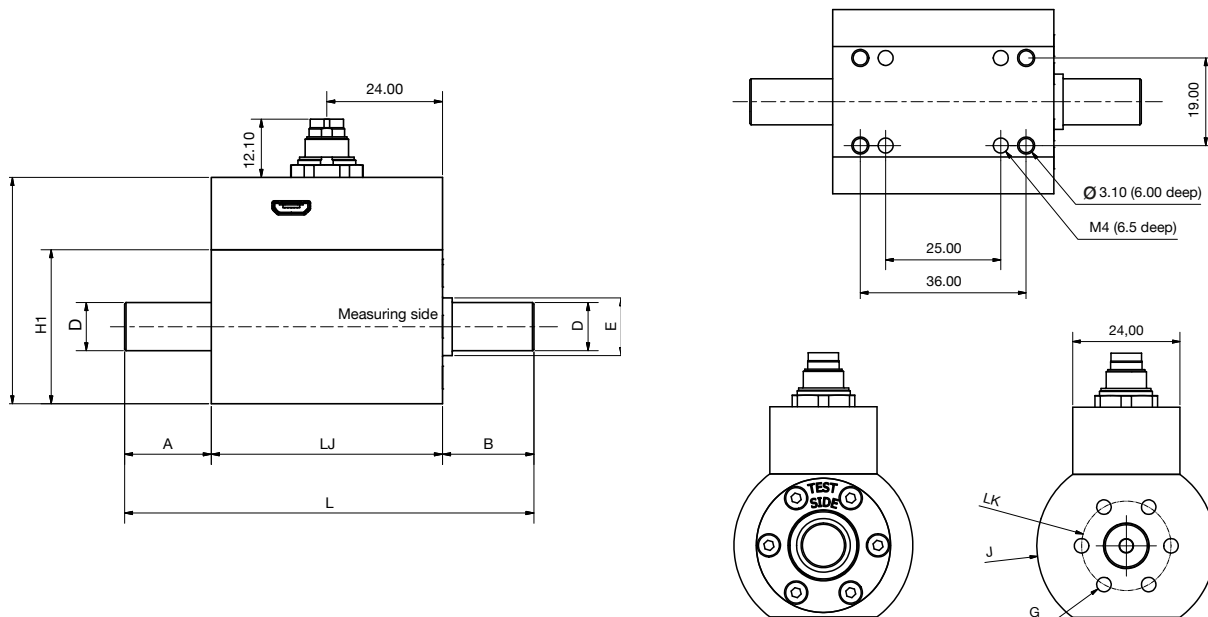

Holes on the sensor underside only up to 10 N.m. For detailed dimensions, including with fitted flange or bracket, you can find sensor CAD data on our website www.burster.com.

Dimensional drawing - measuring ranges 20 Nm ... 200 Nm

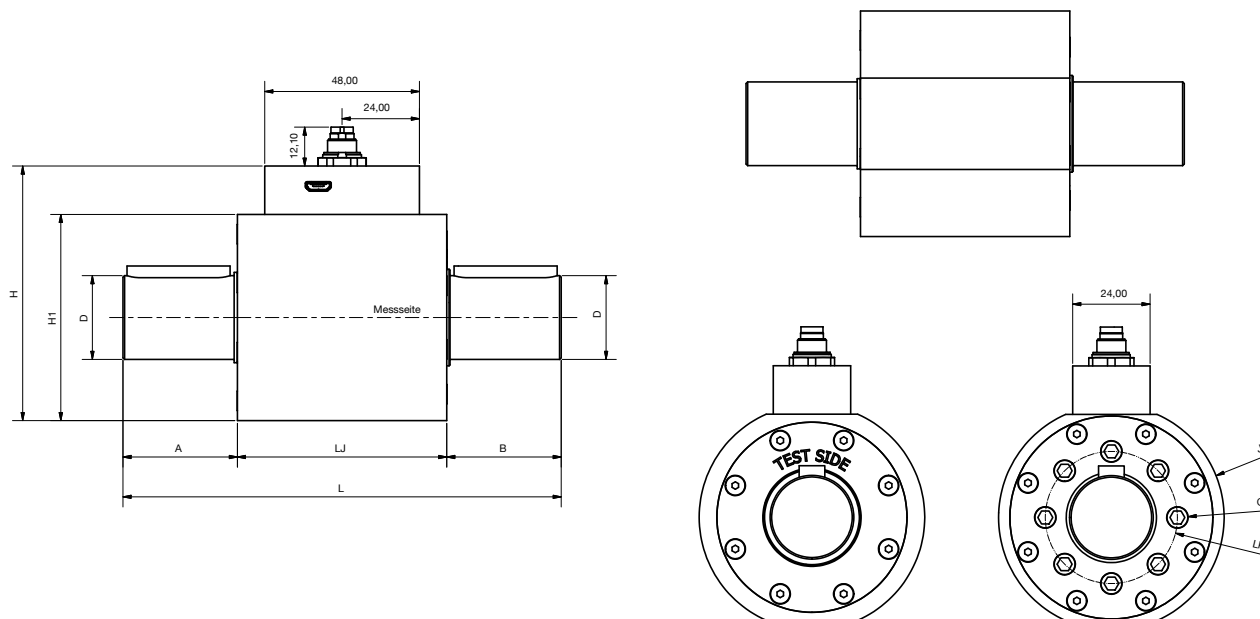

Electrical values

7-pin miniature connector, additionally micro-USB interface for configuration/measurement (Option, USB connection cable included)

Wiring Code depends on the options selected

Pin	Assignment without electronic	Assignment with electronic
1	Bridge supply -	Supply GND
2	Bridge supply +	Supply +5 ... 30 V
3	Shield	Shield
4	Signal +	Output signal ±10 V
5	Signal -	Output signal GND
6	TEDS I/O (option) / NC	Control signal
7	TEDS GND (option) / NC	Switching between ranges (option)

Accessories

Flange-mounted model

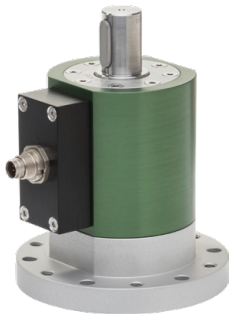

The flange adapter allows easy integration of the sensor in existing equipment with a flange connection. When ordered with the sensor, the flange adapter comes pre-fitted; please refer to order code.

Alternatively it can be ordered separately as an accessory.

Please refer to the accessories data sheet 8600-Z00X

Bracket-mounted model

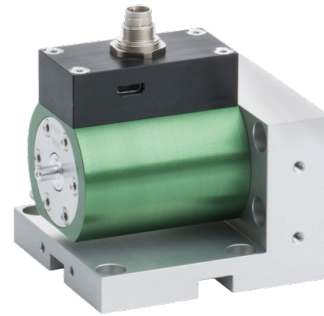

The bracket provides a quick-to-fit and stable fixture for the sensor. When ordered with the sensor, the bracket comes pre-fitted; please refer to order code

Alternatively it can be ordered separately as an accessory.

Please refer to the accessories data sheet 8600-Z00X

Integrated amplifier with USB interface

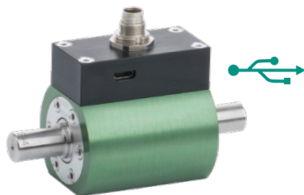

This sensor model comes with a USB port in addition to the $0 \dots \pm 10 \text{ V}$ output.

Two versions are available:

- $\pm 10 \text{ V}$ output signal, USB used solely for configuration
- $\pm 10 \text{ V}$ output signal, USB used for both configuration and measurement

When a USB-based measurement is launched, the analog output signal is disabled because it is not possible to use both forms of output simultaneously.

With both versions, the measurement signal can be tared, averaged or filtered. These functions can be set up and/or activated via USB and the free version of DigiVision.

Metal-bellows couplings



Metal-bellows couplings provide optimum misalignment correction. We recommend torsionally rigid metalbellows couplings. These couplings feature extremely high torsional stiffness under applied torque and extremely low restoring forces. From measuring range $20 \text{ N}\cdot\text{m}$ the metal-bellows couplings model 8695 can be used with keyways.

Please refer to the accessories data sheet 8695.

Dual range

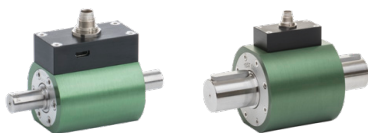

With integrated amplifier and from the 2 Nm measuring range and up, the dual-range option can be selected. The following subdivisions are available:

Graduation:	1:2	1:4	1:5
	Upper scale value of second range		
2 Nm	1 Nm	0,5 Nm	-
5 Nm	-	-	1 Nm
10 Nm	5 Nm	-	2 Nm
20 Nm	10 Nm	5 Nm	-
50 Nm	-	-	10 Nm
100 Nm	50 Nm	-	20 Nm
200 Nm	100 Nm	50 Nm	-

The second, smaller measuring range can be activated via USB or by applying the operating voltage to pin 7.

Support bearing at the test end

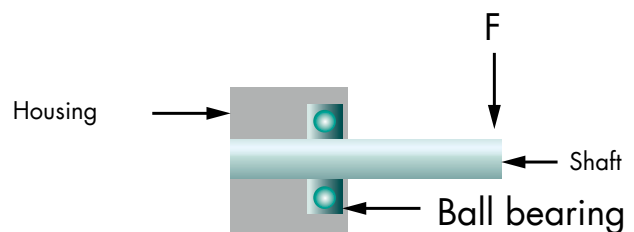

The support bearing option significantly increases the sensor's side load immunity. Especially in manually operated applications, correct application of the torque without parasitic loads usually cannot be guaranteed.

The support bearing largely separates these forces from the measuring element, making measurement results much more reproducible.

DigiVision configuration and analysis software

Features

- Can be used to actuate tare function, with value stored in sensor
- Configuration options for averaging and filters; value stored in sensor
- Intuitive user interface
- Automatic sensor identification
- Sensor calibration data readout

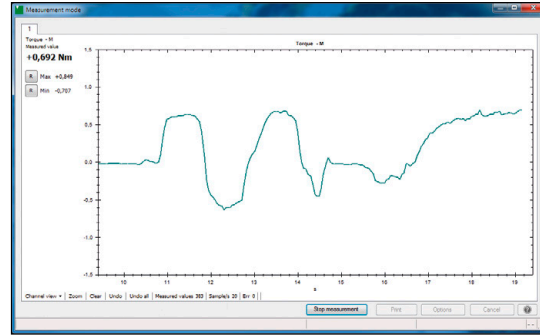

DigiVision Light PC software

freely available on our website

DigiVision configuration and analysis software max. 200 measured value/s for one sensor

DigiVision Standard PC software

Model 8625-P100

DigiVision configuration and analysis software up to 16 channels

PC-Software DigiVision Professional

Model 8625-P200

DigiVision configuration and analysis software with additional configurable maths channel; up to 32 channels

USB measurement option

- Numerical & graphical display and measurement of the physical torque value
- Practical start and stop trigger functions
- 4 limits can be configured for each measurement channel
- MIN/MAX value acquisition
- Automatic scaling
- Measurement reports can be saved as Excel or PDF file
- Archive viewer for displaying sets of curves
- X Multichannel measurements, even with different sensors (e.g. 9206, 8631, 8661) available with standard version

Accessories

Order code

9900-V594	Mating connection 7 pin
9900-V596	Mating connection 90°-angle
99594-000A-0150030	Connecting cable, length 3 m, other end free
99596-000A-0150030	Connecting cable, length 3 m, plug with 90°-angle, other end free
99141-594A-0150030	Connecting cable for burster desktop instruments with 12 pin socket, length 3 m
99209-586C-0510030	For model 9235, model 7281 and model 9311
9900-K358	Micro USB cable, length 1.8 m
8625-P100	DigiVision Standard configuration and analysis software; up to 16 channels
8625-P200	DigiVision Professional with additional configurable maths channel; up to 32 channels
	DigiVision Light configuration and analysis software, max. 200 measured value/s for one sensor (freely available on our website)
8600-Z00X	Flange-mounted or bracket-mounted, see accessories data sheet 8600-Z00X

Calibration

Manufacturer Calibration Certificate (WKS)

Special calibration for clockwise or/and counter clockwise direction torque, in 20 % steps of range up and down.

DAkKS Calibration Certificate

DAkKS calibration certificate per DIN 51309, clockwise and/or anticlockwise torque, with eight steps spaced across the measurement range, increasing and decreasing.

Order Code

Measuring Range		Code			
0 ... ±0.01 N·m		4	0	1	0
0 ... ±0.02 N·m		4	0	2	0
0 ... ±0.05 N·m		4	0	5	0
0 ... ±0.1 N·m		4	1	0	0
0 ... ±0.2 N·m		4	2	0	0
0 ... ±0.5 N·m		4	5	0	0
0 ... ±1 N·m		5	0	0	1
0 ... ±2 N·m		5	0	0	2
0 ... ±5 N·m		5	0	0	5
0 ... ±10 N·m		5	0	1	0
0 ... ±20 N·m		5	0	2	0
0 ... ±50 N·m		5	0	5	0
0 ... ±100 N·m		5	1	0	0
0 ... ±200 N·m		5	2	0	0

					Standard										
					0	0	0	0	0						
8	6	2	5	-						-	V				0

Standard sensor		
■ Standard sensor, one measuring range		0
■ Dual-range version, graduation 1:5 from measuring range 5 N·m		2
■ Dual-range version, graduation 1:4 from measuring range 2 N·m		3
■ Dual-range version, graduation 1:2 from measuring range 2 N·m		4
■ Without additional support bearings on the measuring side		0
■ With additional support bearings on the measuring side		1
Output signals		
■ Output voltage 10 V incl. configuration USB		0
■ Output voltage 10 V incl. USB configuring and measuring USB		1
■ Output signal standardized, mV/V		3
■ Output signal, mV/V with TEDS		4
Versions		
■ Both round shaft ends		0
■ Flange-mounted		4
■ Incl. Bracket-mounted		7