

**ROLLON**<sup>®</sup>  
BY TIMKEN

*Clean Room System*



## > **Clean Room System**



### **1 ONE series**

ONE series description

CRS-2

The components

CRS-3

The linear motion system

CRS-4

ONE 50

CRS-5

ONE 65

CRS-6

ONE 80

CRS-7

ONE 110

CRS-8

Planetary gear

CRS-9

Accessories

CRS-10

Ordering key

CRS-12

Static load and service life

SL-2

Static load and service life Uniline















SL-4

Data sheet

SL-9

# Pre-selection overview



Application Priority	Driving system	Section
<p>Max. speed from 4 to 15 [m/s]                      Max. acceleration from 10 to 50 [m/s<sup>2</sup>]                      Stroke up to 10 m</p>	 Belt	 Square
		 Rectangular
		 Other section
<p>High precision up to <math>\pm 0,005</math> [mm]                      Stroke up to 3.5 m</p>	 Ball screw	 Square
		 Rectangular
<p>Heavy loads up to 4.000 Kg                      Infinite stroke                      Multiple independent carriages</p>	 Rack and pinion	 Rectangular
		 Other section
<p>Vertical mounting                      Profile moving</p>	 Ω Belt	 Square
		 Rectangular
		 Rectangular
		 Other section

\* Optimal reliability in dirty environments thanks to plastic compound coated rollers

Protection	Rollon solution		
	Product Family		Product
 Protected	Plus System		ELM
	Modline		MCR/MCH with protection
 Semi-protected	Eco System		ECO
	Modline		MCR/MCH
	Uniline System		UNILINE
Open	Smart System		E-SMART
 Protected with suction	Clean Room System		ONE
 Protected	Plus System		ROBOT
Open	Smart System		R-SMART
	Modline		TCR/TCS
Open*	Speedy Rail A		SAB
 Semi-protected	Precision System		TV
			TVS
			TT
			TH
Open	Tecline		PAS
			PAR
Open*	Speedy Rail A		SAR
 Semi-protected	Smart System		S-SMART
 Semi-protected	Plus System		SC
Open	Modline		ZCR/ZCH
Open*	Speedy Rail A		ZSY

# Technical features overview



Reference		Section		Driving			Anticorrosion	Protection
Product Family	Product	Balls	Rollers	Toothed belt	Ball screw	Rack and pinion		
Plus System		ELM						 Protected
		ROBOT						 Protected
		SC						 Semi-protected
Clean Room System		ONE						 Protected with suction
Smart System		E-SMART						
		R-SMART						
		S-SMART						 Semi-protected
Eco System		ECO						 Semi-protected
Uniline System		A/C/E/ED/H						 Semi-protected
Modline		MCR MCH						 Semi-protected
		TCR TCS						
		ZCR ZCH						
		ZMCH						





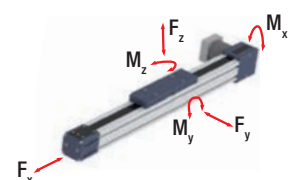







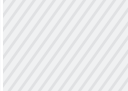
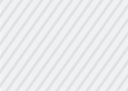

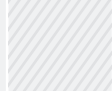
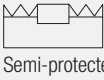

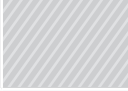
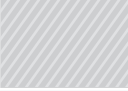

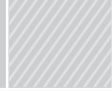

















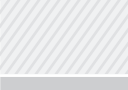







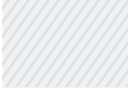

Reported data must be verified according to the application.  
\* Longer stroke is available for jointed version

Size	Max. load capacity per carriage [N]			Max. static moment per carriage [Nm]			Max. speed [m/s]	Max. acceleration [m/s <sup>2</sup> ]	Repeatability accuracy [mm]	Max stroke (per system) [mm]
	F <sub>x</sub>	F <sub>y</sub>	F <sub>z</sub>	M <sub>x</sub>	M <sub>y</sub>	M <sub>z</sub>				
50-65-80-110	4980	129400	129400	1392	11646	11646	5	50	± 0,05	6000*
100-130-160-220	9545	258800	258800	22257	28986	28986	5	50	± 0,05	6000*
65-130-160	6682	153600	153600	13555	31104	31104	5	50	± 0,05	2500
50-65-80-110	4980	104800	104800	1126	10532	10532	5	50	± 0,05	6000*
30-50-80-100	4980	130860	130860	1500	12039	12039	4	50	± 0,05	6000*
120-160-220	9960	258800	258800	21998	28468	28468	4	50	± 0,05	6000*
50-65-80	2523	51260	51260	520	3742	3742	4	50	± 0,05	2000
60-80-100	4565	76800	76800	722	7603	7603	5	50	± 0,05	6000*
40-55-75	19360	11000	17400	800,4	24917	18788	7	15	± 0,05	5700*
65-80-105	3984	51260	51260	520	5536	5536	5	50	± 0,1	10100*
140-170 200-220-230 280-360	9960	266400	266400	42624	61272	61272	5	50	± 0,1	11480
60-90-100 170-220	7470	174480	174480	12388	35681	35681	4	25	± 0,1	2500
105	4980	61120	61120	3591	10390	10390	3	25	± 0,1	2100

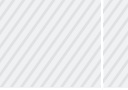
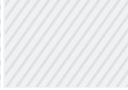
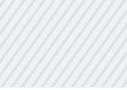
P  
L  
SC  
R  
SS  
SE  
SU  
SM  
L

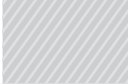
# Technical features overview

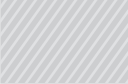

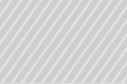
Reference		Section		Driving			Anticorrosion	Protection
Product Family	Product	Balls	Rollers	Toothed belt	Ball screw	Rack and pinion		
Precision System		TH						 Semi-protected
		TT						 Semi-protected
		TV						 Semi-protected
		TVS						 Semi-protected
Tecline		PAR PAS						
Speedy Rail A		SAB						
		ZSY						
		SAR						

Reported data must be verified according to the application.

\* Longer stroke is available for jointed version

Size	Max. load capacity per carriage [N]			Max. static moment per carriage [Nm]			Max. speed [m/s]	Max. acceleration [m/s <sup>2</sup> ]	Repeatability accuracy [mm]	Max stroke (per system) [mm]
	F <sub>x</sub>	F <sub>y</sub>	F <sub>z</sub>	M <sub>x</sub>	M <sub>y</sub>	M <sub>z</sub>				
70-90-110-145	32600	153600	153600	6682	5053	5053	2		± 0,005	1500
100-155-225-310	30500	230500	274500	30195	26625	22365	2,5		± 0,005	3000
60-80-110	11538	85000	85000	1080	2316	2316	2,5		± 0,01	3000
170-220	66300	258800	258800	19410	47360	47360	1	5	± 0,02	3500
118-140-170-200-220-230-280-360	10989	386400	386400	65688	150310	150310	4	10	± 0,05	10800*
60-120-180-250	4565	3620	3620	372	362	362	15	10	± 0,2	7150
180	4980	2300	2600	188	806	713	8	8	± 0,2	6640
120-180-250	3598	3620	3620	372	453	453	3	10	± 0,15	7150*

P  
S  
  
T  
L  
  
S  
R  
A

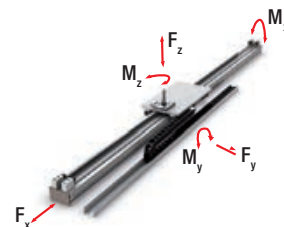



**ONE series****> ONE series description**

Fig. 1

The ONE series actuators are belt driven linear actuators specifically designed for Clean Room applications. The ONE series is certified compliant with ISO CLASS 3 (DIN EN ISO 14644-1) and CLASS 1 US FED STD 209E cleanroom standards by the Fraunhofer Institute IPA in Stuttgart.

The ONE series reduces particle contamination using a specially designed straight seal that isolates the internals of the actuator from the environment. In addition to particle containment, the ONE series can support a vacuum pump (up to 0,8 bar) to remove and transport contaminates from the interior of the actuator to filtration sites. The 2 vacuum ports are located on the drive and idle head.

All internal components of the ONE series actuators are designed to minimize particle release. Component materials are limited to stainless steel. Where stainless steel is not an option, special treatments are used to ensure low particle release.

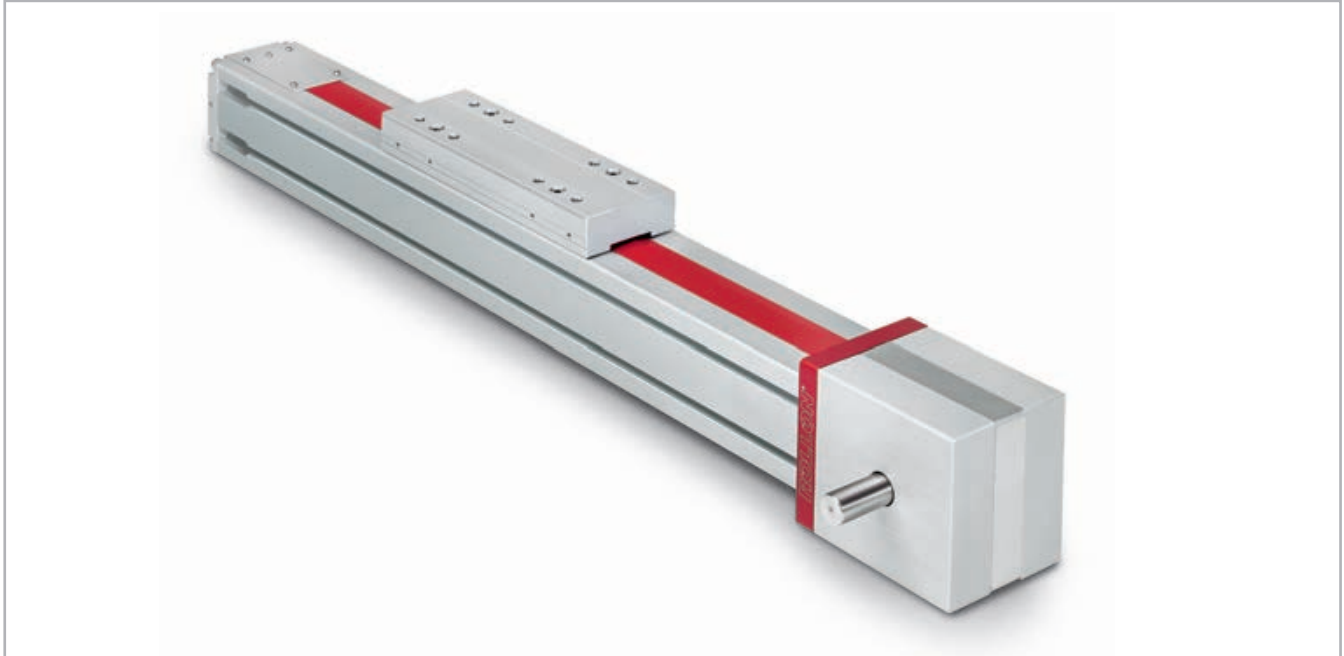
Special lubrications designed for use in cleanroom or vacuum environments are used for all bearings and linear rails.

## > The components

### Extruded bodies

The anodized aluminum extrusions used for the bodies of the Rollon ONE series linear units were designed and manufactured in cooperation with a leading company in this field to obtain the right combination of high mechanical strength and reduced weight. Aluminum alloy 6060 is used (see physical-chemical characteristics below). The dimensional tolerances comply with EN 755-9 standard.

### Driving belt

ONE Series is the first linear units driven by timing belt capable to achieve ISO CLASS 3.

We are using selected high quality polyurethane timing belts, AT profile, manufactured by leading companies in this field.

### Carriage

The carriage of the Rollon ONE series linear units are made entirely of anodized aluminum. Each carriage has mounting holes fitted with stainless steel thread inserts. Rollon offers multiple carriages to accommodate a vast array of applications. The unique design of the carriage allows for the sealing strip to pass through the carriage.

### Sealing strip

Rollon ONE series linear units are equipped with a polyurethane sealing strip to prevent particles generated inside the unit to go outside. The sealing strip runs the length of the body and is kept in position by micro-bearings located with in the carriage. This minimizes frictional resistance as the strip passes through the carriage while providing maximum protection.

### General data about aluminum used: AL 6060

Chemical composition [%]

Al	Mg	Si	Fe	Mn	Zn	Cu	Impurities
Remainder	0.35-0.60	0.30-0.60	0.30	0.10	0.10	0.10	0.05-0.15

Tab. 1

Physical characteristics

Density	Coeff. of elasticity	Coeff. of thermal expansion (20°-100°C)	Thermal conductivity (20°C)	Specific heat (0°-100°C)	Resistivity	Melting point
$\frac{\text{kg}}{\text{dm}^3}$	$\frac{\text{kN}}{\text{mm}^2}$	$\frac{10^{-6}}{\text{K}}$	$\frac{\text{W}}{\text{m} \cdot \text{K}}$	$\frac{\text{J}}{\text{kg} \cdot \text{K}}$	$\Omega \cdot \text{m} \cdot 10^{-9}$	°C
2.7	69	23	200	880-900	33	600-655

Tab. 2

Mechanical characteristics

Rm	Rp (02)	A	HB
$\frac{\text{N}}{\text{mm}^2}$	$\frac{\text{N}}{\text{mm}^2}$	%	—
205	165	10	60-80

Tab. 3

## > The linear motion system

### Certified Clean Room Class

ONE Series is a device tested by FRAUNHOFER IPA Institute - Stuttgart (D). Rollon achieved the ISO CLASS 3 (DIN EN ISO 14644-1) and CLASS 1 US FED STD 209E cleanroom standard using a combination of a vacuum pump and our special sealing belt (Intl. Patend Pending).

### Vacuum system

The ONE series actuator has specific connection ports on the drive and the idle end of the unit to connect a vacuum system. The vacuum quality must be evaluated case by case, but Rollon has had success with 0,8 bar on a ONE 80 with a stroke of 1.000 mm up to 4.000 mm. A vacuum was used in conjunction to Rollon's special sealing strip to achieve ISO CLASS 3 (DIN EN ISO 14644-1) and CLASS 1 US FED STD 209E

### Selected mechanical components

ONE Series is assembled with select high-quality components. Only Stainless Steel (AISI 303, AISI 440C) is used for bearings, linear guides, shafts, pulleys, and other metallic components. Where it is impossible to use Stainless Steel, Rollon provides a special treatment tested under severe conditions and under particle generation.

### ONE SP section

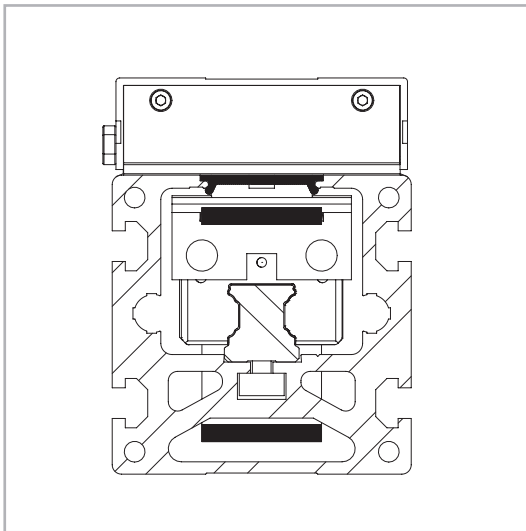

Fig. 2

### Lubrication

ONE Series is equipped with "innovate and hi-tech linear guides" that feature special ball cages to maintain spacing. This feature supports a long-term maintenance and a low particle generation if combined with special lubricant, specifically developed and adopted for Clean Room applications.

### Range

ONE Series is now available in 3 different sizes, for multi axes combinations:

- ONE 50
- ONE 65
- ONE 80
- ONE 110

Maximum stroke is 6.000 mm, except ONE 50 where the maximum stroke is 3.700 mm.

For technical details and load capacities, please refer to next pages.



INTL. PATENT PENDING

> ONE 50

ONE 50 Dimension

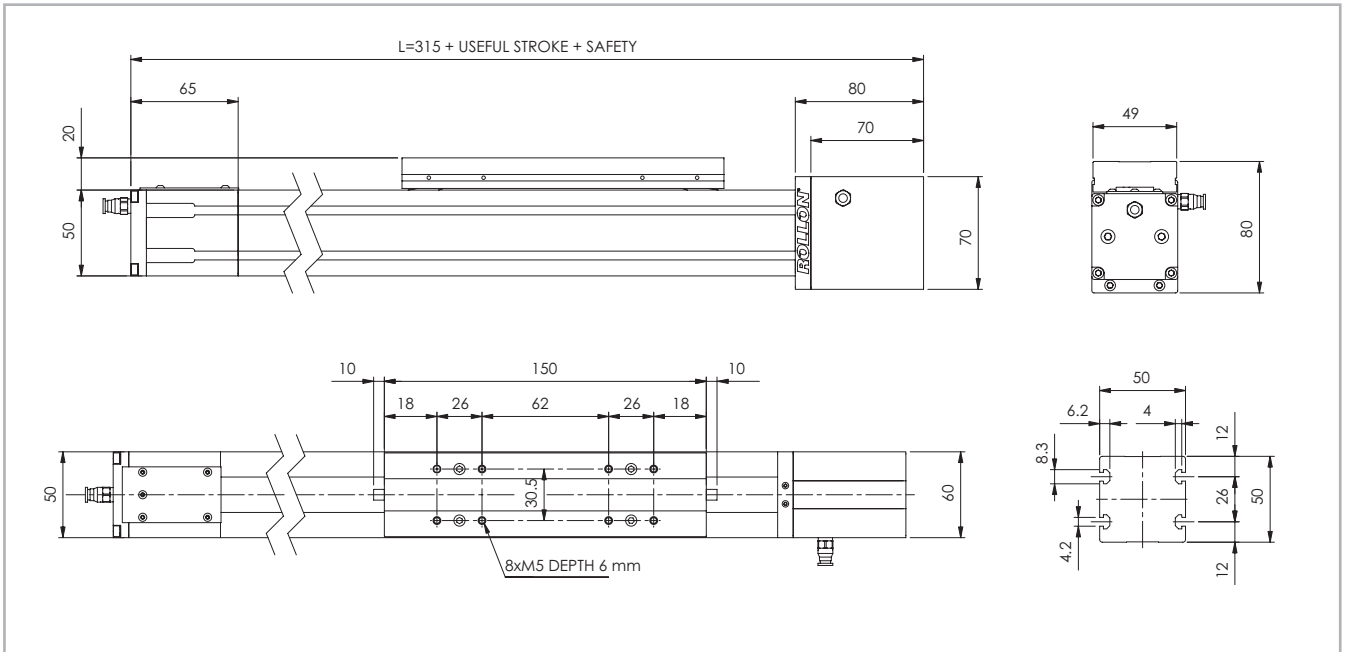

For further details please visit our website [www.rollon.com](http://www.rollon.com) and download the related DXF files.

Fig. 3

Technical data

	Type
	ONE 50
Max. useful stroke length [mm]	3700
Max. positioning repeatability [mm]*1	± 0.05
Max. speed [m/s]	4
Max. acceleration [m/s <sup>2</sup> ]	50
Type of belt	22 AT 5
Type of pulley	Z 23
Pulley pitch diameter [mm]	36,61
Carriage displacement per pulley turn [mm]	115
Carriage weight [kg]	0.4
Zero travel weight [kg]	1.8
Weight for 100 mm useful stroke [kg]	0.4
Starting torque [Nm]	0.4
Moment of inertia of pulleys [g mm <sup>2</sup> ]	19810
Rail size [mm]	12 mini

\*1) Positioning repeatability is dependent on the type of transmission used

Tab. 4

ONE 50 - Load capacity

Type	F <sub>x</sub> [N]		F <sub>y</sub> [N]		F <sub>z</sub> [N]	M <sub>x</sub> [Nm]	M <sub>y</sub> [Nm]	M <sub>z</sub> [Nm]
	Stat.	Dyn.	Stat.	Dyn.	Stat.	Stat.	Stat.	Stat.
ONE 50	809	508	7060	6350	7060	46.2	233	233

See verification under static load and lifetime on page SL-2 and SL-3

Tab. 7

Moments of inertia of the aluminum body

Type	I <sub>x</sub> [10 <sup>7</sup> mm <sup>4</sup> ]	I <sub>y</sub> [10 <sup>7</sup> mm <sup>4</sup> ]	I <sub>p</sub> [10 <sup>7</sup> mm <sup>4</sup> ]
ONE 50	0.025	0.031	0.056

Tab. 5

Driving belt

The driving belt is manufactured from a friction resistant polyurethane and with steel cords for high tensile stress resistance.

Type	Type of belt	Belt width [mm]	Weight kg/m
ONE 50	22 AT 5	22	0.072

Tab. 6

Belt length (mm) = 2 x L - 130

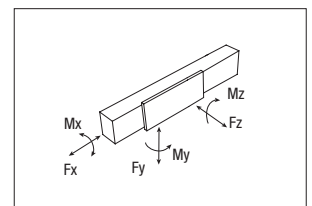

> ONE 65

ONE 65 Dimension

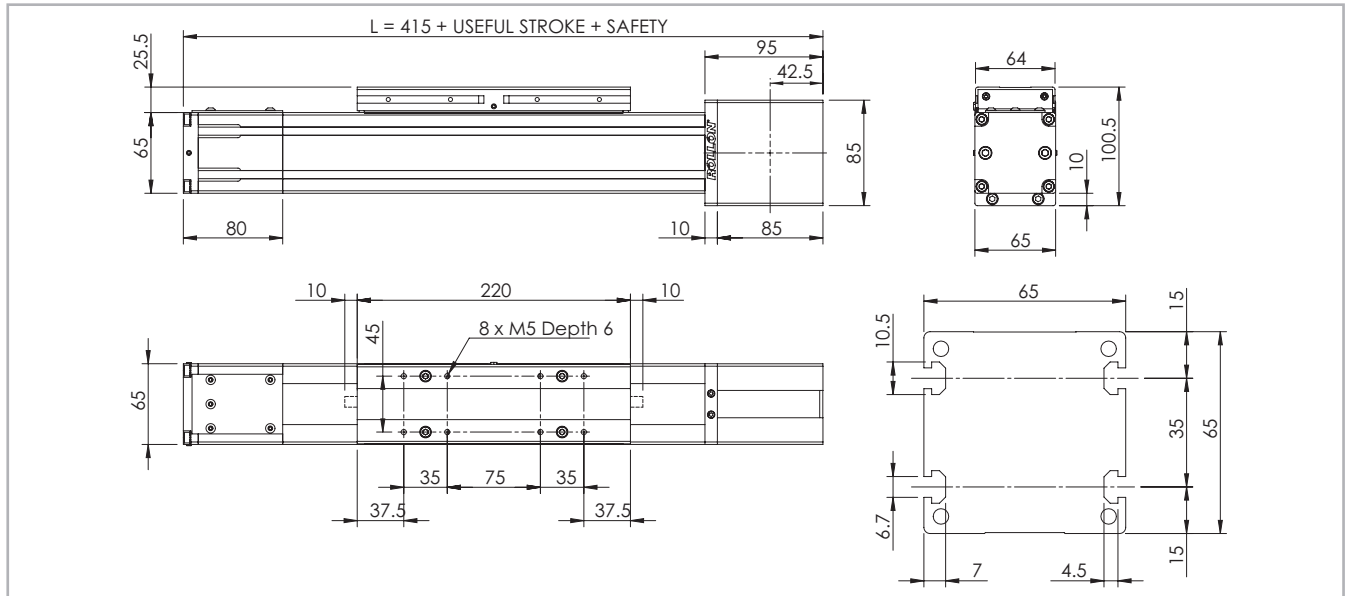

For further details please visit our website [www.rollon.com](http://www.rollon.com) and download the related DXF files.

Fig. 4

Technical data

	Type
	ONE 65
Max. useful stroke length [mm]	6000
Max. positioning repeatability [mm]*1	± 0.05
Max. speed [m/s]	5.0
Max. acceleration [m/s <sup>2</sup> ]	50
Type of belt	32 AT 5
Type of pulley	Z 32
Pulley pitch diameter [mm]	50.93
Carriage displacement per pulley turn [mm]	160
Carriage weight [kg]	1.1
Zero travel weight [kg]	3.5
Weight for 100 mm useful stroke [kg]	0.6
Starting torque [Nm]	1.5
Moment of inertia of pulleys [g mm <sup>2</sup> ]	117200
Rail size [mm]	15

\*1) Positioning repeatability is dependent on the type of transmission used

Tab. 8

Moments of inertia of the aluminum body

Type	$I_x$ [10 <sup>7</sup> mm <sup>4</sup> ]	$I_y$ [10 <sup>7</sup> mm <sup>4</sup> ]	$I_p$ [10 <sup>7</sup> mm <sup>4</sup> ]
ONE 65	0.060	0.086	0.146

Tab. 9

Driving belt

The driving belt is manufactured from a friction resistant polyurethane and with steel cords for high tensile stress resistance.

Type	Type of belt	Belt width [mm]	Weight kg/m
ONE 65	32 AT 5	32	0.105

Tab. 10

Belt length (mm) = 2 x L - 180

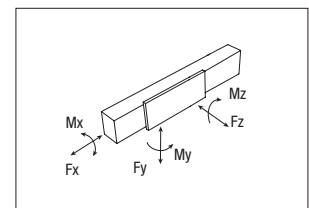

ONE 65 - Load capacity

Type	$F_x$ [N]		$F_y$ [N]		$F_z$ [N]	$M_x$ [Nm]	$M_y$ [Nm]	$M_z$ [Nm]
	Stat.	Dyn.	Stat.	Dyn.	Stat.	Stat.	Stat.	Stat.
ONE 65	1344	883	48400	22541	48400	320	1376	1376

See verification under static load and lifetime on page SL-2 and SL-3

Tab. 11

> ONE 80

ONE 80 Dimension

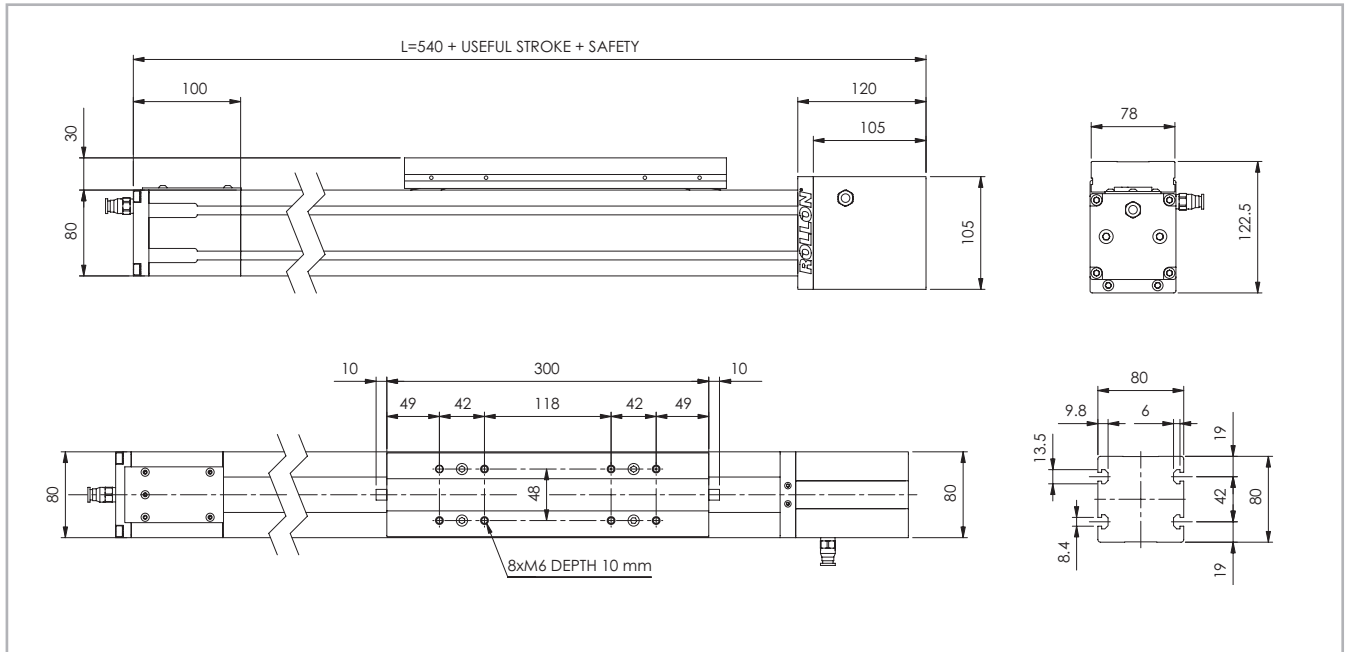

For further details please visit our website [www.rollon.com](http://www.rollon.com) and download the related DXF files.

Fig. 5

Technical data

	Type
	ONE 80
Max. useful stroke length [mm]	6000
Max. positioning repeatability [mm]*1	± 0.05
Max. speed [m/s]	5
Max. acceleration [m/s <sup>2</sup> ]	50
Type of belt	32 AT 10
Type of pulley	Z 19
Pulley pitch diameter [mm]	60.48
Carriage displacement per pulley turn [mm]	190
Carriage weight [kg]	2.7
Zero travel weight [kg]	10.5
Weight for 100 mm useful stroke [kg]	1
Starting torque [Nm]	2.2
Moment of inertia of pulleys [g mm <sup>2</sup> ]	388075
Rail size [mm]	20

\*1) Positioning repeatability is dependent on the type of transmission used

Tab. 12

ONE 80 - Load capacity

Type	F <sub>x</sub> [N]		F <sub>y</sub> [N]		F <sub>z</sub> [N]	M <sub>x</sub> [Nm]	M <sub>y</sub> [Nm]	M <sub>z</sub> [Nm]
	Stat.	Dyn.	Stat.	Dyn.	Stat.	Stat.	Stat.	Stat.
ONE 80	2258	1306	76800	35399	76800	722	5606	5606

See verification under static load and lifetime on page SL-2 and SL-3

Tab. 15

Moments of inertia of the aluminum body

Type	I <sub>x</sub> [10 <sup>7</sup> mm <sup>4</sup> ]	I <sub>y</sub> [10 <sup>7</sup> mm <sup>4</sup> ]	I <sub>b</sub> [10 <sup>7</sup> mm <sup>4</sup> ]
ONE 80	0.136	0.195	0.331

Tab. 13

Driving belt

The driving belt is manufactured from a friction resistant polyurethane and with steel cords for high tensile stress resistance.

Type	Type of belt	Belt width [mm]	Weight kg/m
ONE 80	32 AT 10	32	0.185

Tab. 14

Belt length (mm) = 2 x L - 230

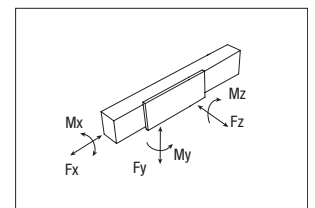

> ONE 110

ONE 110 Dimension

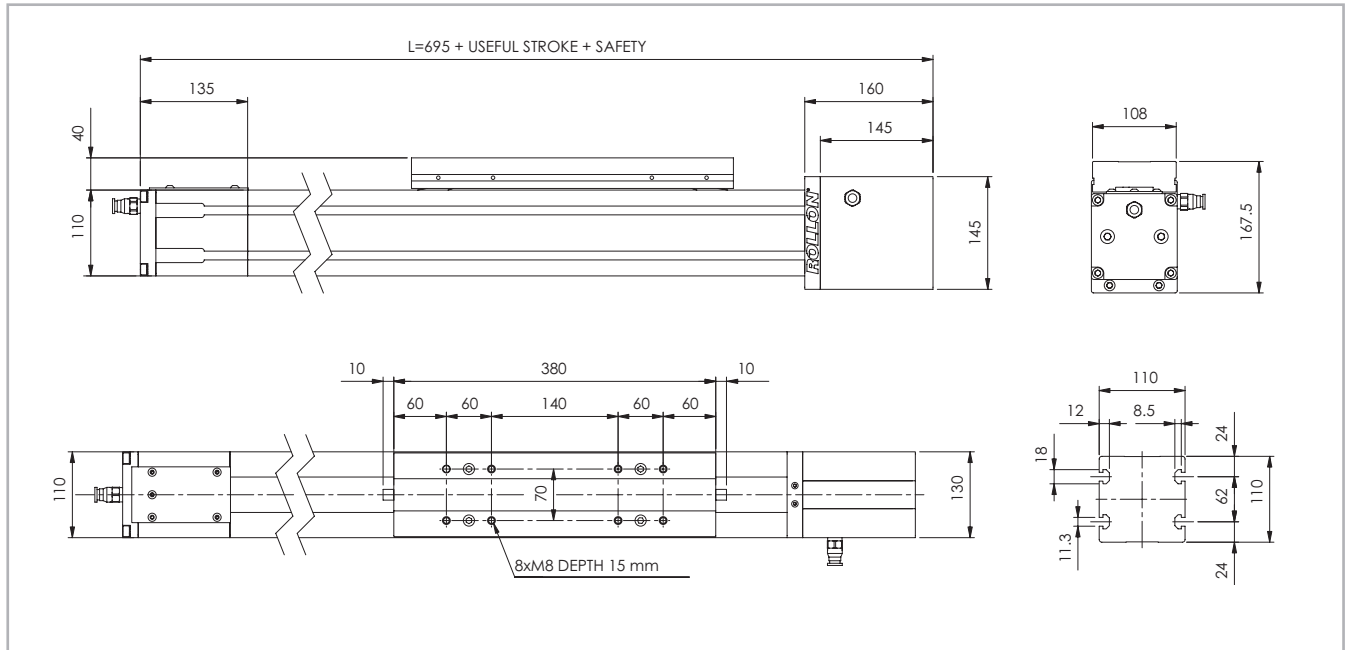

For further details please visit our website [www.rollon.com](http://www.rollon.com) and download the related DXF files.

Fig. 6

Technical data

	Type
	ONE 110
Max. useful stroke length [mm]	6000
Max. positioning repeatability [mm]*1	± 0.05
Max. speed [m/s]	5
Max. acceleration [m/s <sup>2</sup> ]	50
Type of belt	50 AT 10
Type of pulley	Z 27
Pulley pitch diameter [mm]	85.94
Carriage displacement per pulley turn [mm]	270
Carriage weight [kg]	5.6
Zero travel weight [kg]	22.5
Weight for 100 mm useful stroke [kg]	1.4
Starting torque [Nm]	3.5
Moment of inertia of pulleys [g mm <sup>2</sup> ]	2.193 · 10 <sup>6</sup>
Rail size [mm]	25

\*1) Positioning repeatability is dependant on the type of transmission used

Tab. 16

Moments of inertia of the aluminum body

Type	$I_x$ [10 <sup>7</sup> mm <sup>4</sup> ]	$I_y$ [10 <sup>7</sup> mm <sup>4</sup> ]	$I_p$ [10 <sup>7</sup> mm <sup>4</sup> ]
ONE 110	0.446	0.609	1.054

Tab. 17

Driving belt

The driving belt is manufactured from a friction resistant polyurethane and with steel cords for high tensile stress resistance.

Type	Type of belt	Belt width [mm]	Weight kg/m
ONE 110	50 AT 10	50	0.290

Tab. 18

Belt length (mm) = 2 x L - 290

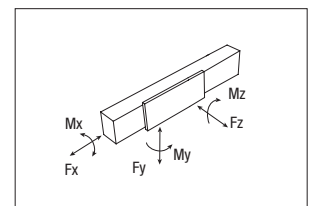

ONE 110 - Load capacity

Type	$F_x$ [N]		$F_y$ [N]		$F_z$ [N]	$M_x$ [Nm]	$M_y$ [Nm]	$M_z$ [Nm]
	Stat.	Dyn.	Stat.	Dyn.	Stat.	Stat.	Stat.	Stat.
ONE 110	4980	3300	104800	50321	104800	1126	10532	10532

See verification under static load and lifetime on page SL-2 and SL-3

Tab. 19

## > Planetary gears

### Assembly to the right or to the left of the driving head

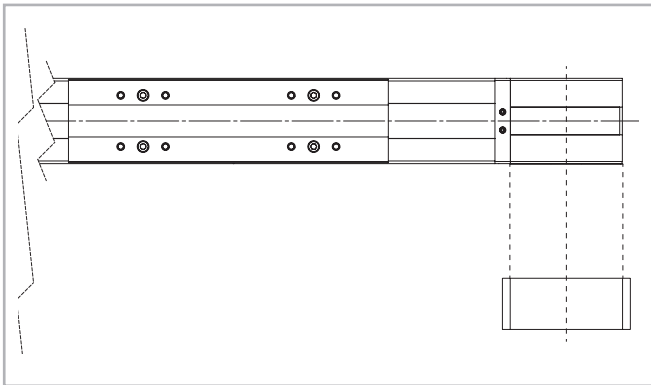
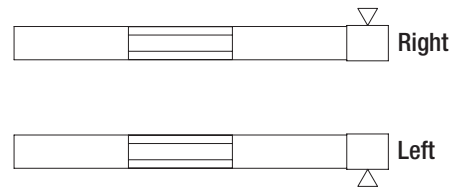

Fig. 7

The series ONE linear units can be fitted with several different drive systems. In each case, the driving pulley is attached to the reduction gearshaft by means of a tapered coupling to ensure high accuracy over a long period of time.

### Versions with planetary gears

Planetary gears are used for highly dynamic robot, automation and handling applications involving stressing cycles and with high level precision requirements. Standard models are available with clearance from 3' to 15' and with a reduction ratio from 1:3 to 1:1000. For assembly of non-standard planetary gear, contact our offices.



### Shaft with centering

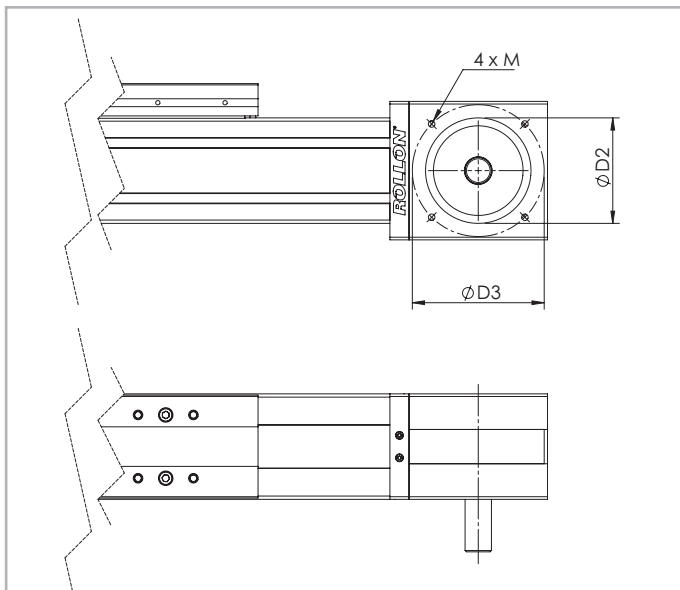

Fig. 8

Unit	Shaft type	D2	D3	M	Head code AS left	Head code AS right
ONE 50	AS 12	55	70	M5	VB	VA
ONE 65	AS 15	60	85	M6	VB	VA
ONE 80	AS 20	80	100	M6	VB	VA
ONE 110	AS 25	110	130/160	M8	VB	VA

Tab. 20



## > Accessories

### Fixing by brackets

The linear motion systems used for the Rollon series ONE linear units enables them to support loads in any direction. They can therefore be installed in any position.

To install the units, we recommend the use of the dedicated T-Slots in the extruded bodies as shown below.

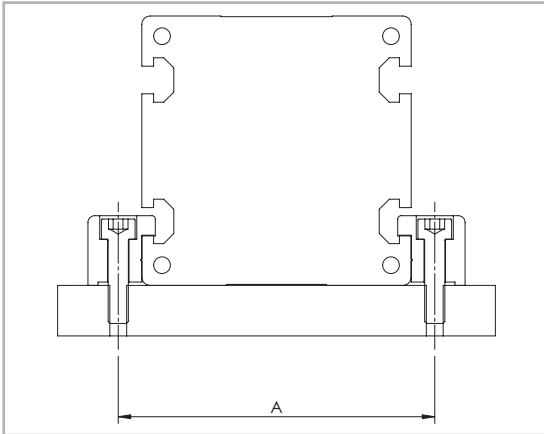

Fig. 9

Unit	A (mm)
ONE 50	62
ONE 65	77
ONE 80	94
ONE 110	130

Tab. 21

### Warning:

Do not fix the linear units through the drive ends.

### Fixing brackets

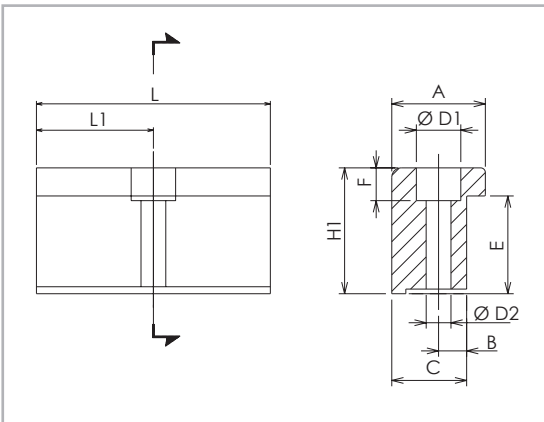

Fig. 10

### Dimensions (mm)

Unit	A	H1	B	C	E	F	D1	D2	L	L1	Code
ONE 50	20	14	6	16	10	6	10	5.5	35	17.5	1000958
ONE 65	20	17.5	6	16	11.5	6	9.4	5.3	50	25	1001490
ONE 80	20	20.7	7	16	14.7	7	11	6.4	50	25	1001491
ONE 110	36.5	28.5	10	31	18.5	11.5	16.5	10.5	100	50	1001233

Tab. 22

### Fixing bracket

Anodized aluminum block for fixing the linear units through the side T-Slots of the body.

### T-Nuts

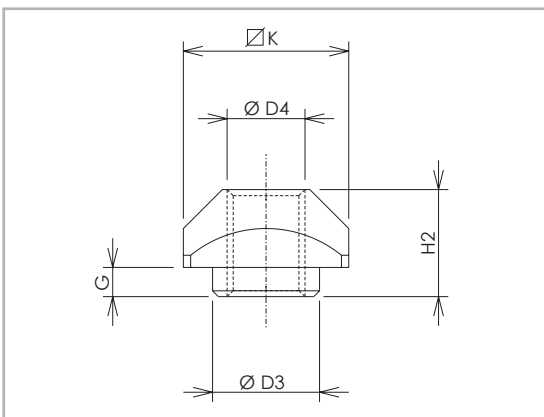

Fig. 11

### Dimensions (mm)

Unit	D3	D4	G	H2	K	Code
ONE 50	-	M4	-	3.4	8	1001046
ONE 65	6.7	M5	2.3	6.5	10	1000627
ONE 80	8	M6	3.3	8.3	13	1000043
ONE 110	11	M8	2.8	10.8	17	1000932

Tab. 23

### T-nuts

Steel nuts to be used in the slots of the body.

## Proximity

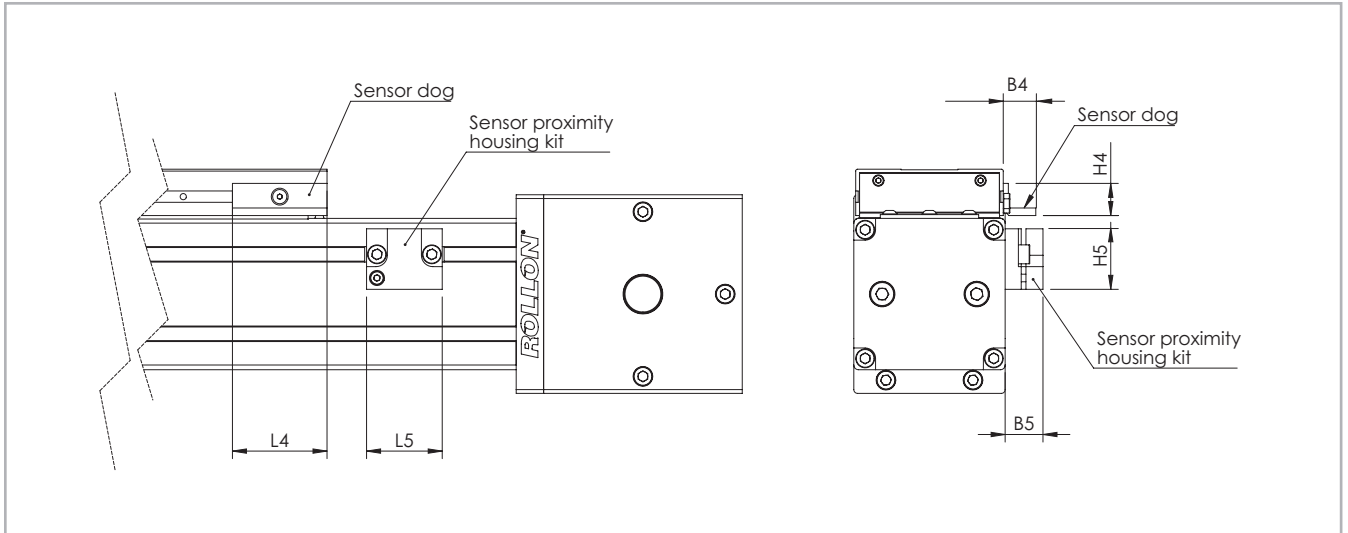

Fig. 12

**Sensor proximity housing kit**

Red anodized aluminum sensor holder, equipped with T-nuts for fixing onto the profile.

**Sensor dog**

L-shaped bracket in zinc-plated iron, mounted on the carriage and used for proximity switch operations.

**Dimensions (mm)**

Unit	B4	B5	L4	L5	H4	H5	For proximity	Sensor dog code	Sensor proximity housing kit code
ONE 50	9.5	14	25	29	11.9	22.5	Ø 8	G000268	G000211
ONE 65	17.2	20	50	40	17	32	Ø 12	G000267	G000212
ONE 80	17.2	20	50	40	17	32	Ø 12	G000267	G000209
ONE 110	17.2	20	50	40	17	32	Ø 12	G000267	G000210

Tab. 24

# Ordering key

> Identification codes for the ONE linear unit

N	08	VA	02000	3B	
	05=50				
	06=65				
	08=80				
	10=100				
					SP stainless steel <i>see pg. CRS-3</i>
					L= total length of the unit
					Driving head code <i>see pg. CRS-9</i>
					Linear unit size <i>see from pg. CRS-5 to pg. CRS-8</i>
					ONE Series <i>see pg. CRS-2</i>

In order to create identification codes for Actuator Line, you can visit: <http://configureactuator.rollon.com>



Left / right orientation

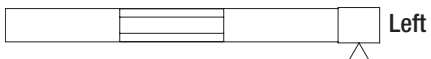

# Static load and service life

## > Static load

In the static load test, the radial load rating  $F_y$ , the axial load rating  $F_z$ , and the moments  $M_x$ ,  $M_y$  und  $M_z$  indicate the maximum allowed load values. Higher loads will impair the running characteristics. To check the static load, a safety factor  $S_0$  is used, which accounts for the special conditions of the application defined in more detail in the table below:

All load capacity values refer to the actuator well fixed to a rigid structure. For cantilever applications the deflection of the actuator profile must be taken in account.

### Safety factor $S_0$

No shocks or vibrations, smooth and low-frequency change in direction High mounting accuracy, no elastic deformations, clean environment	2 - 3
Normal assembly conditions	3 - 5
Shocks and vibrations, high-frequency changes in direction, substantial elastic deformations	5 - 7

Fig. 1

The ratio of the actual to the maximum allowed load must not be higher than the reciprocal value of the assumed safety factor  $S_0$ .

$\frac{P_{fy}}{F_y} \leq \frac{1}{S_0}$	$\frac{P_{fz}}{F_z} \leq \frac{1}{S_0}$	$\frac{M_1}{M_x} \leq \frac{1}{S_0}$	$\frac{M_2}{M_y} \leq \frac{1}{S_0}$	$\frac{M_3}{M_z} \leq \frac{1}{S_0}$
---	---	--------------------------------------	--------------------------------------	--------------------------------------

Fig. 2

The above formulae only apply to a one load case. If one or more of the forces described are acting simultaneously, the following calculation must be carried out:

$\frac{P_{fy}}{F_y} + \frac{P_{fz}}{F_z} + \frac{M_1}{M_x} + \frac{M_2}{M_y} + \frac{M_3}{M_z} \leq \frac{1}{S_0}$	$P_{fy}$	= acting load (y direction) (N)
	$F_y$	= static load rating (y direction) (N)
	$P_{fz}$	= acting load (z direction) (N)
	$F_z$	= static load rating (z direction) (N)
	$M_1, M_2, M_3$	= external moments (Nm)
	$M_x, M_y, M_z$	= maximum allowed moments in the different load directions (Nm)

Fig. 3

The safety factor  $S_0$  can be at the lower limit given if the acting forces can be determined with sufficient accuracy. If shocks and vibrations act on the system, the higher value should be selected. In dynamic applications, higher safeties are required. For further information, please contact our Application Engineering Department.

### Belt safety factor referred to the dynamic $F_x$

Impact and vibrations	Speed / acceleration	Orietation	Safety Factor
<b>No impacts and/or vibrations</b>	Low	horizontal	1.4
		vertical	1.8
<b>Light impacts and/or vibrations</b>	Medium	horizontal	1.7
		vertical	2.2
<b>Strong impacts and/or vibrations</b>	High	horizontal	2.2
		vertical	3

Tab. 1

## > Service life

### Calculation of the service life

The dynamic load rating  $C$  is a conventional quantity used for calculating the service life. This load corresponds to a nominal service life of 100 km.

The calculated service life, dynamic load rating and equivalent load are linked by the following formula:

$$L_{km} = 100 \text{ km} \cdot \left( \frac{Fz\text{-dyn}}{P_{eq}} \cdot \frac{1}{f_i} \right)^3$$

$L_{km}$  = theoretical service life (km)  
 $Fz\text{-dyn}$  = dynamic load rating (N)  
 $P_{eq}$  = acting equivalent load (N)  
 $f_i$  = service factor (see tab. 2)

Fig. 4

The effective equivalent load  $P_{eq}$  is the sum of the forces and moments acting simultaneously on a slider. If these different load components are known,  $P$  is obtained from the following equation:

### For SP types

$$P_{eq} = P_{fy} + P_{fz} + \left( \frac{M_1}{M_x} + \frac{M_2}{M_y} + \frac{M_3}{M_z} \right) \cdot F_y$$

Fig. 5

### For CI and CE types

$$P_{eq} = P_{fy} + \left( \frac{P_{fz}}{F_z} + \frac{M_1}{M_x} + \frac{M_2}{M_y} + \frac{M_3}{M_z} \right) \cdot F_y$$

Fig. 6

The external constants are assumed to be constant over time. Short-term loads that do not exceed the maximum load ratings have no relevant effect on the service life and can therefore be neglected in the calculation.

### Service factor $f_i$

$f_i$	
no shocks or vibrations, smooth and low-frequency changes in direction; ( $\alpha < 5\text{m/s}^2$ ) clean operating conditions; low speeds (<1 m/s)	1.5 - 2
Slight vibrations; medium speeds; (1-2 m/s) and medium-high frequency of the changes in direction ( $5\text{m/s}^2 < \alpha < 10\text{m/s}^2$ )	2 - 3
Shocks and vibrations; high speeds (>2 m/s) and high-frequency changes in direction; ( $\alpha > 10\text{m/s}^2$ ) high contamination, very short stroke	> 3

Tab. 2

### Speedy Rail A Lifetime

The rated lifetime for SRA actuators is 80,000 Km.

# Static load and service life Uniline



## > Static load

In the static load test, the radial load rating  $F_y$ , the axial load rating  $F_z$ , and the moments  $M_x$ ,  $M_y$  and  $M_z$  indicate the maximum allowed load values. Higher loads will impair the running characteristics. To check the static load, a safety factor  $S_0$  is used, which accounts for the special conditions of the application defined in more detail in the table below:

### Safety factor $S_0$

No shocks or vibrations, smooth and low-frequency change in direction High mounting accuracy, no elastic deformations, clean environment	1 - 1.5
Normal assembly conditions	1.5 - 2
Shocks and vibrations, high-frequency changes in direction, substantial elastic deformations	2 - 3.5

Fig. 7

The ratio of the actual to the maximum allowed load must not be higher than the reciprocal value of the assumed safety factor  $S_0$ .

$\frac{P_{fy}}{F_y} \leq \frac{1}{S_0}$	$\frac{P_{fz}}{F_z} \leq \frac{1}{S_0}$	$\frac{M_1}{M_x} \leq \frac{1}{S_0}$	$\frac{M_2}{M_y} \leq \frac{1}{S_0}$	$\frac{M_3}{M_z} \leq \frac{1}{S_0}$
---	---	--------------------------------------	--------------------------------------	--------------------------------------

Fig. 8

The above formulae apply to a one load case. If one or more of the forces described are acting simultaneously, the following test must be carried out:

$\frac{P_{fy}}{F_y} + \frac{P_{fz}}{F_z} + \frac{M_1}{M_x} + \frac{M_2}{M_y} + \frac{M_3}{M_z} \leq \frac{1}{S_0}$	<p><math>P_{fy}</math> = acting load (y direction) (N)  <math>F_y</math> = static load rating (y direction) (N)  <math>P_{fz}</math> = acting load (z direction) (N)  <math>F_z</math> = static load rating (z direction) (N)  <math>M_1, M_2, M_3</math> = external moments (Nm)  <math>M_x, M_y, M_z</math> = maximum allowed moments in the different load directions (Nm)</p>
--	---

Fig. 9

The safety factor  $S_0$  can be at the lower limit given if the acting forces can be determined with sufficient accuracy. If shocks and vibrations act on the system, the higher value should be selected. In dynamic applications, higher safeties are required. For further information, please contact our Application Engineering Department.

## > Calculation formulae

### Moments $M_y$ and $M_z$ for linear units with long slider plate

The allowed loads for the moments  $M_y$  and  $M_z$  depend on the length of the slider plate. The allowed moments  $M_{zn}$  and  $M_{yn}$  for each slider plate length are calculated by the following formulae:

$$S_n = S_{min} + n \cdot \Delta S$$

$$M_{zn} = \left(1 + \frac{S_n - S_{min}}{K}\right) \cdot M_{zmin}$$

$$M_{yn} = \left(1 + \frac{S_n - S_{min}}{K}\right) \cdot M_{ymin}$$

$M_{zn}$  = allowed moment (Nm)

$M_{zmin}$  = minimum values (Nm)

$M_{yn}$  = allowed moment (Nm)

$M_{ymin}$  = minimum values (Nm)

$S_n$  = length of the slider plate (mm)

$S_{min}$  = minimum length of the slider plate (mm)

$\Delta S$  = factor of the change in slider length

$K$  = constant

Fig. 10

Type	$M_{ymin}$ [Nm]	$M_{zmin}$ [Nm]	$S_{min}$ [mm]	$\Delta S$	$K$
A40L	22	61	240	10	74
A55L	82	239	310		110
A75L	287	852	440		155
C55L	213	39	310		130
C75L	674	116	440		155
E55L	165	239	310		110
E75L	575	852	440		155
ED75L ( $M_z$ )	1174	852	440		155
ED75L ( $M_y$ )	1174	852	440		270

Tab. 3

**Moments  $M_y$  and  $M_z$  for linear units with two slider plates**

The allowed loads for the moments  $M_y$  and  $M_z$  are related to the value of the distance between the centers of the sliders. The allowed moments  $M_{y,n}$  and  $M_{z,n}$  for each distance between the centers of the sliders are calculated by the following formulae:

$L_n = L_{min} + n \cdot \Delta L$ $M_y = \left( \frac{L_n}{L_{min}} \right) \cdot M_{y,min}$ $M_z = \left( \frac{L_n}{L_{min}} \right) \cdot M_{z,min}$	<p><math>M_y</math> = allowed moment (Nm)</p> <p><math>M_z</math> = allowed moment (Nm)</p> <p><math>M_{y,min}</math> = minimum values (Nm)</p> <p><math>M_{z,min}</math> = minimum values (Nm)</p> <p><math>L_n</math> = distance between the centers of the sliders (mm)</p> <p><math>L_{min}</math> = minimum value for the distance between the centers of the sliders (mm)</p> <p><math>\Delta L</math> = factor of the change in slider length</p>
--	--

Fig. 11

Type	$M_{y,min}$ [Nm]	$M_{z,min}$ [Nm]	$L_{min}$ [mm]	$\Delta L$
A40D	70	193	235	5
A55D	225	652	300	5
A75D	771	2288	416	8
C55D	492	90	300	5
C75D	1809	312	416	8
E55D	450	652	300	5
E75D	1543	2288	416	8
ED75D	3619	2288	416	8

Tab. 4

**> Service life**

**Calculation of the service life**

The dynamic load rating C is a conventional quantity used for calculating the service life. This load corresponds to a nominal service life of 100 km. The corresponding values for each liner unit are listed in Table 45 shown

below. The calculated service life, dynamic load rating and equivalent load are linked by the following formula:

$L_{km} = 100 \text{ km} \cdot \left( \frac{C}{P} \cdot \frac{f_c}{f_i} \cdot f_n \right)^3$	<p><math>L_{km}</math> = theoretical service life (km)</p> <p>C = dynamic load rating (N)</p> <p>P = acting equivalent load (N)</p> <p><math>f_i</math> = service factor (see tab. 5)</p> <p><math>f_c</math> = contact factor (see tab. 6)</p> <p><math>f_n</math> = stroke factor (see fig. 13)</p>
--	---

Fig. 12

The effective equivalent load P is the sum of the forces and moments acting simultaneously on a slider. If these different load components are known, P is obtained from the following equation:



$$P = P_{fy} + \left( \frac{P_{fz}}{F_z} + \frac{M_1}{M_x} + \frac{M_2}{M_y} + \frac{M_3}{M_z} \right) \cdot F_y$$

Fig. 13

The external constants are assumed to be constant over time. Short-term loads that do not exceed the maximum load ratings have no relevant effect on the service life and can therefore be neglected in the calculation.

### Service factor $f_i$

$f_i$	
No shocks or vibrations, smooth and low-frequency changes in direction; clean operating conditions; low speeds (<1 m/s)	1 - 1.5
Slight vibrations; medium speeds; (1-2,5 m/s) and medium-high frequency of the changes in direction	1.5 - 2
Shocks and vibrations; high speeds (>2.5 m/s) and high-frequency changes in direction; high contamination	2 - 3.5

Tab. 5

### Contact factor $f_c$

$f_c$	
Standard slider	1
Long slider	0.8
Double slider	0.8

Tab. 6

### Stroke factor $f_h$

The stroke factor  $f_h$  accounts for the higher stress on the raceways and rollers when short strokes are carried out at the same total run distance. The following diagram shows the corresponding values (for strokes above 1 m,  $f_h$  remains 1):

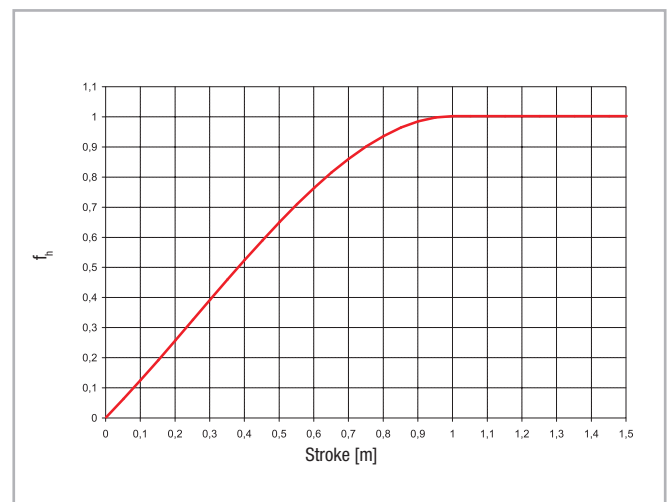

Fig. 14

## > Determination of the motor torque

The torque  $C_m$  required at the drive head of the linear axis is calculated by the following formula:

$$C_m = C_v + \left( F \cdot \frac{D_p}{2} \right)$$

- $C_m$  = torque of the motor (Nm)
- $C_v$  = starting torque (Nm)
- $F$  = force acting on the toothed belt (N)
- $D_p$  = pitch diameter of pulley (m)

Fig. 15

**Data sheet** 

General data: Date: ..... Inquiry N°: .....

Address: ..... Contact: .....

Company: ..... Zip Code: .....

Phone: ..... Fax: .....

E-Mail: .....

**Technical data:**

				X axis	Y axis	Z axis
<b>Useful stroke</b> (Including safety overtravel)		S	[mm]			
<b>Load to be translated</b>		P	[kg]			
<b>Location of Load in the</b>	X-Direction	LxP	[mm]			
	Y-Direction	LyP	[mm]			
	Z-Direction	LzP	[mm]			
<b>Additional force</b>	Direction (+/-)	Fx (Fy, Fz)	[N]			
<b>Position of force</b>	X-Direction	Lx Fx (Fy, Fz)	[mm]			
	Y-Direction	Ly Fx (Fy, Fz)	[mm]			
	Z-Direction	Lz Fx (Fy, Fz)	[mm]			
<b>Assembly position</b> (Horizontal/Vertical/Transversal)						
<b>Max. speed</b>		V	[m/s]			
<b>Max. acceleration</b>		a	[m/s <sup>2</sup> ]			
<b>Positioning repeatability</b>		Δs	[mm]			
<b>Required life</b>		L	yrs			

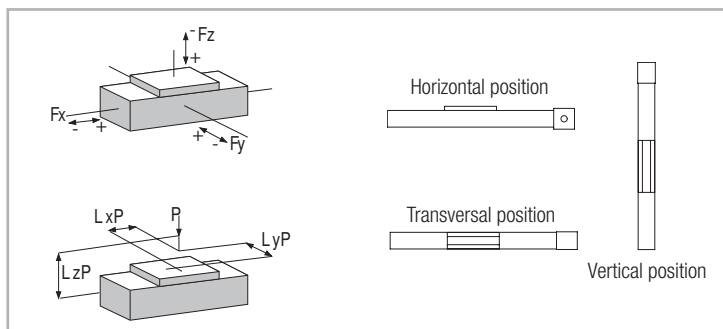

**Attention:** Please enclose drawing, sketches and sheet of the duty cycle



● Rollon Branches & Rep. Offices  
● Distributors

## EUROPE

**ROLLON S.p.A. - ITALY (Headquarters)** ▼

Via Trieste 26  
I-20871 Vimercate (MB)  
Phone: (+39) 039 62 59 1  
www.rollon.it - infocom@rollon.it

**ROLLON GmbH - GERMANY** ▼

Bonner Strasse 317-319  
D-40589 Düsseldorf  
Phone: (+49) 211 95 747 0  
www.rollon.de - info@rollon.de

**ROLLON S.A.R.L. - FRANCE** ▼

Les Jardins d'Eole, 2 allée des Séquoias  
F-69760 Limonest  
Phone: (+33) (0) 4 74 71 93 30  
www.rollon.fr - infocom@rollon.fr

**ROLLON B.V. - NETHERLANDS** ▼

Ringbaan Zuid 8  
6905 DB Zevenaar  
Phone: (+31) 316 581 999  
www.rollon.nl - info@rollon.nl

**ROLLON S.p.A. - RUSSIA (Rep. Office)** ▼

117105, Moscow, Varshavskoye  
shosse 17, building 1  
Phone: +7 (495) 508-10-70  
www.rollon.ru - info@rollon.ru

**ROLLON Ltd - UK (Rep. Office)** ▼

The Works 6 West Street Olney  
Buckinghamshire, United Kingdom, MK46 5 HR  
Phone: +44 (0) 1234964024  
www.rollon.uk.com - info@rollon.uk.com

## AMERICA

**ROLLON Corporation - USA** ▼

101 Bilby Road. Suite B  
Hackettstown, NJ 07840  
Phone: (+1) 973 300 5492  
www.rolloncorp.com - info@rolloncorp.com

**ROLLON - SOUTH AMERICA (Rep. Office)** ▼

R. Joaquim Floriano, 397, 2o. andar  
Itaim Bibi - 04534-011, São Paulo, BRASIL  
Phone: +55 (11) 3198 3645  
www.rollonbrasil.com.br - info@rollonbrasil.com

## ASIA

**ROLLON Ltd - CHINA** ▼

No. 1155 Pang Jin Road,  
China, Suzhou, 215200  
Phone: +86 0512 6392 1625  
www.rollon.cn.com - info@rollon.cn.com

**ROLLON India Pvt. Ltd. - INDIA** ▼

1st floor, Regus Gem Business Centre, 26/1  
Hosur Road, Bommanahalli, Bangalore 560068  
Phone: (+91) 80 67027066  
www.rollonindia.in - info@rollonindia.in

**ROLLON - JAPAN** ▼

3F Shiodome Building, 1-2-20 Kaigan, Minato-ku,  
Tokyo 105-0022 Japan  
Phone +81 3 6721 8487  
www.rollon.jp - info@rollon.jp

Consult the other ranges of products



Distributor

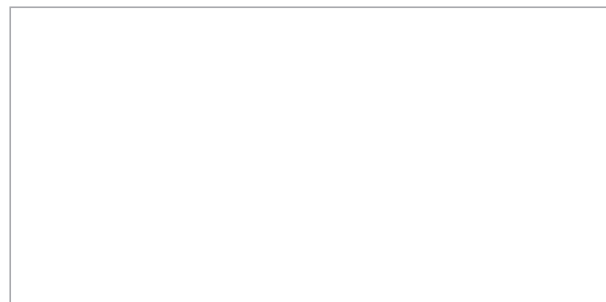

All addresses of our global sales partners can also be found at [www.rollon.com](http://www.rollon.com)

The content of this document and its use are subject to the general terms of sale of ROLLON available on the web site [www.rollon.com](http://www.rollon.com)  
Changes and errors expected. The text and images may be used only with our permission.