



for latest edition
and updates **check**
www.powercapacitors.info



PK16™ AND E61 – HIGH DENSITY DC FILM CAPACITORS



THE IDEAL CHOICE FOR YOUR DC LINK

ELECTRONICON®
always in charge

Choose the best capacitor
for any of your power electronics applications:

AC and DC capacitors with integrated safety mechanism
E62 AC/DC E62-3ph AC Filter E63 DC

Low-inductance capacitors
E50 PK16™ DC E53 AC/DC E61 DC

Low-inductance High-voltage capacitors
E51

AC and DC capacitors with large capacitance
E56 DC E59 AC/DC E70 AC E50.U SR17™ DC

CAPACITORS

ELECTRONICON®

always in charge

PK16™ and E61

HIGH DENSITY DC FILM CAPACITORS

DC KONDENSATOREN MIT HOHER ENERGIEDICHTE





PK16™ – ideal for your high-current DC-circuit

The PK16™ capacitor can be universally used for the assembly of low inductance DC buffer circuits and DC filters; with its high energy density it can replace banks of series-connected electrolytic capacitors as well as large film capacitors in rectangular cases.

The capacitance in a DC buffer circuit must be sufficiently sized to both handle and smoothen the occurring ripple currents. The traditional use of series-/parallel-connected electrolytic capacitors offered large capacitance at seemingly low cost, however the low cost per microfarad is countered by the very low current strength, the high sensitivity to voltage and current surges, as well as high risk of failures in the field, resulting in high maintenance cost.

Our advanced know-how in special capacitor film coating and many years of practical experience in designing and manufacturing capacitors have allowed us to design our PK16™ range with high capacitance density. With fivefold the current strength of conventional electrolytic capacitors, it is not necessary to reproduce the same capacitance in film technology.

Instead, the user now gets a superior technical solution within the same – or even less – space, offering

- superior voltage and current strength
- dramatic increase in operational life
- drastic reduction of failures
- minimization of power dissipation losses
- substantial reduction of self-inductance and series resistance
- more exact manufacturing tolerances
- elimination of sharing resistors

PK16 XI™ and PK16 XC™ – Current and Capacitance as you need it

While the capacitors of our PK16 XI™ range are optimized for your lean DC link with maximum available current and best possible cooling, the PK16 XC™ range offers another extra in capacitance where strong current capability is to be combined with perfect smoothing.

Thanks to its compact cylindrical aluminium (NT/NZ) or plastic (N4) can design this capacitor is ideal for both the electrical and mechanical requirements of high-speed IGBT converters.

PK16™ – Ideal für die hohen Ströme Ihres Zwischenkreises

Der PK16™ Kondensator lässt sich universell zum Aufbau niederinduktiver DC Zwischenkreise und für DC Filter einsetzen und kann mit seiner hohen Energiedichte sowohl Batterien serienschalteter Elektrolytkondensatoren als auch große quaderförmige Folienkondensatoren ersetzen.

Die Kapazität in einem DC-Zwischenkreis muß groß genug sein, um auftretende überlagerte Wechselspannungen zu glätten und entsprechende Rippleströme zu bewältigen. Die traditionelle Serien-/Parallelschaltung von Elektrolytkondensatoren bietet hohe Kapazität zu scheinbar niedrigen Kosten, jedoch steht den geringen Kosten je Mikrofarad eine sehr niedrige Strombelastbarkeit, hohe Stoßstrom- und Spannungsempfindlichkeit sowie ein erhebliches Ausfallrisiko im Feld gegenüber, welches sich in hohen Wartungskosten niederschlägt.

Unser hochentwickeltes Know-How in der Metallisierung von Kondensatorfolien und langjährige praktische Erfahrungen in der Entwicklung und Herstellung von Kondensatoren ermöglichten uns die Schaffung unserer PK16™ Serie mit hoher Kapazitätsdichte. Dank fünffacher Stromfestigkeit gegenüber üblichen Elektrolytkondensatoren ist es nicht mehr notwendig, exakt die gleiche Kapazität in Folientechnologie zu erreichen, um einen gegebenen Strom zu bewältigen.

Statt dessen erhält der Anwender eine hochwertige technische Lösung mit gleichem oder vermindertem Platzbedarf und folgenden Vorteilen:

- höhere Spannungs- und Stromfestigkeit
- drastische Verlängerung der Lebensdauer
- bemerkenswerte Reduzierung von Ausfällen
- Minimierung der Verlustleistung
- erhebliche Verringerung der Eigeninduktivität und des Serienwiderstandes
- genauere Produktionstoleranzen
- Eliminierung von Symmetrierwiderständen

PK16 XI™ und PK16 XC™ – Strom und Kapazität ganz nach Ihren Wünschen

Während die Kondensatoren unserer PK16 XI™-Reihe mit höchstmöglichem Strom und verbesserter Kühlung für Ihren schlanken Zwischenkreis optimiert sind, bietet die PK16 XC™-Reihe ein zusätzliches Plus an Kapazität für die Anwendungsfälle, in denen zuverlässige Stromfestigkeit in Kombination mit perfekter Glättung gefragt ist.

Mit seiner kompakten zylindrischen Bauform in Aluminium- (NT/NZ) oder Kunststoffgehäuse (N4) ist der Kondensator optimal an elektrische und mechanische Erfordernisse in schnelltaktenden IGBT Stromrichtern angepasst.



Its robust terminals and the robust fixing stud allow for very simple and reliable mounting that unites lowest inductance and highest current strength. The particularly large clearance and creepage distances make this design suitable for a wide range of operating voltages. As a result, existing standard converter concepts can easily be adapted to new applications without having to change the principal construction and to re-approve the entire system.

Important notice

Our MKP capacitors of the PK16™ series are made with self-healing dielectric. In the event of voltage breakdowns, caused by weak spots in the dielectric or high thermal/electrical load, the metal coating around the breakdown spot is vaporized within a few microseconds. As a result, the area around the breakdown spot is de-metalized, and the capacitor remains fully functional.

The release of energy during a regular self-healing breakdown, and the amount of gas generated in the process, are so small that even after thousands of such self-healing procedures there is no significant build-up of overpressure inside the capacitor.

The scenario of self-healing breakdown becomes less likely, or impossible, under high thermal or electrical overstress. The disintegration of the polypropylene dielectric may produce more or less amounts of gas accompanied by a build-up of internal pressure. Very frequent and large-scale occurrence of self-healing breakdowns (e.g., as a result of strong voltage overstrain) may cause a gradual rise of the internal pressure of capacitors with hermetically sealed cans as well.

For the sake of lowest available self-inductance and maximum mounting comfort, the capacitors of our PK16™ range are not equipped with an integrated safety mechanism to disconnect them in the event of overload or failure. They should therefore not be operated beyond their rated values and be allocated in uncritical environment (non-inflammable materials) where build-up of pressure or even ignition of the polypropylene cannot cause consequential damage.

Die robusten Anschlusselemente und eine stabile Bodenbefestigung ermöglichen eine besonders einfache Montage, die niedrigste Induktivität und hohe Strombelastbarkeit miteinander vereinigt. Die außerordentlich großen Luft- und Kriechstrecken decken einen weiten Spannungsbereich ab, ohne dass dadurch die Bauform gewechselt werden müsste. Damit kann ein Standard-Stromrichterkonzept sehr viel flexibler auf unterschiedliche Anwendungen ausgerichtet werden, ohne neue Konstruktionen und damit neue Systemprüfungen erforderlich zu machen.

Wichtiger Hinweis

Alle in unseren PK16™-Kondensatoren verwendeten dielektrischen Strukturen sind selbstheilend. Im Falle eines Kurzschlusses (z.B. Spannungsdurchschlag an Schwachstellen im Dielektrikum, oder infolge starker thermischer/elektrischer Belastung) verdampfen binnen weniger Mikrosekunden die Metallbeläge rings um den Durchschlagpunkt und bilden eine belagfreie, isolierende Zone. Dabei bleibt der Kondensator voll funktionsfähig.

Die freigesetzte Energie während eines selbstheilenden Durchschlages und die dabei erzeugte Menge an Gas sind so gering, dass selbst nach tausenden solcher Selbstheilungsvorgänge kein nennenswerter Überdruck im Kondensatorinneren entsteht.

Der zuverlässige Ablauf selbstheilender Durchschläge kann jedoch durch hohe thermische oder elektrische Belastung beeinträchtigt oder verhindert werden. Sich zersetzendes Polypropylen erzeugt dann größere Mengen an Gas und der Innendruck im Kondensator steigt. Gleichermaßen können auch häufig und großflächig auftretende Durchschläge (z.B. infolge starker Überspannung) in hermetisch dichten Kondensatoren einen starken Anstieg des Innendrucks verursachen.

Zum Zwecke niedrigster Eigeninduktivität und maximalen Einbaukomforts verfügen die Kondensatoren unserer PK16™ Reihe nicht über einen internen Abschaltmechanismus für Fehlerfälle oder spannungsmäßige Überlastung. Sie sollten daher nicht außerhalb ihrer zulässigen Nennwerte betrieben und stets in unkritischer Umgebung (nichtentflammbare Materialien) platziert werden, wo Gasfreisetzung bzw. ein Entzünden des Dielektrikums keine schwerwiegenden Folgeschäden verursachen können.



for latest edition and updates
check www.powercapacitors.info

E50.*PK16XI™**
DC
600...700V

Low-inductance DC Capacitors
Niederinduktive Zwischenkreiskondensatoren



Standards IEC 61071, optional IEC 61881
UL 810
can Gehäuse aluminium/plastic, (UL94: V0)
mounting position optional
Einbaulage beliebig
filling material solid, based on vegetable oil, non-PCB
Füllmittel ausgehärtet, auf Pflanzenölbasis, PCB-frei
internal protection none
interne Sicherung keine
fire load Brandlast 40 MJ/kg

C_N tolerance Toleranz ±10%; optional ±5%
tanδ₀ 2 × 10⁻⁴
limit temperatures Grenztemperaturen
Θ_{min} -40°C
Θ_{max} (HOTSPOT) +85°C¹
storing temperature Lagertemperatur -40°C ... +85°C
Life time Lebensdauer > 200 000 h
Failure rate Ausfallrate 50 FIT²
¹endurance type test_Lebensdauertest: Ø 116 @80°C, Ø 136 @75°C
²reference service life_Referenzbetriebsdauer 100000 h, Θ_{HOTSPOT} ≤70°C

PK16 XI™ – Maximum Current and Large Capacitance _Maximaler Strom und große Kapazitätsdichte

C _N (µF)	R _s (mΩ)	R _{th} (K/W)	I _{max} (A)	Î (kA)	I _s (kA)	E _N (W _s)	L _e (nH)	D ₁ × L ₁ (mm)	Design	m (kg)	order no. Bestell-Nr.	pcs / Box Stk / Box
U_N 600V DC			U_s 900V		U_r 100V		U_{BB} 900V DC		U_{BG} 3300V AC/2s			
1080	1	3.7	60	7.4	22	194	40	85 × 155	NZ	0.9	E50.N15-115NZ0	5 / FB8
1560	1.3	2.7	60	7.4	22	281	60	85 × 210	NZ	1.25	E50.N21-165NZ0	5 / FB9
2000	1.4	2.3	60	7.4	22	360	60	85 × 252	NT	1.6	E50.N25-205NT0	5 / FB10
2000	0.51	2.3	80	13.7	41	360	40	116 × 165	NT	1.9	E50.R16-205NT0	3 / FB8
3000	0.53	1.7	100	21	62	540	50	116 × 230	NT	2.5	E50.R23-305NT0	3 / FB9
4000	0.58	1.3	100	28	83	720	70	116 × 295	NT	3.2	E50.R29-405NT0	3 / FB10
5000	0.72	1.1	100	20	60	900	70	116 × 345	NT	3.5	E50.R34-505NT0	3 / FB15
5600	0.55	1.1	120	30	90	1008	70	136 × 295	NT	4.5	E50.S29-565NT0	2 / FB11
7000	0.66	0.9	120	29	87	1260	70	136 × 345	NT	5.3	E50.S34-705NT0	2 / FB13
U_N 700V DC			U_s 1050V		U_r 200V		U_{BB} 1050V DC		U_{BG} 3300V AC/2s			
800	1.1	3.7	60	6.4	19	198	40	85 × 155	NZ	0.9	E50.N15-804NZ0	5 / FB8
1170	1.3	2.7	60	6.5	19.5	287	60	85 × 210	NZ	1.25	E50.N21-125NZ0	5 / FB9
1460	0.54	2.3	80	11.7	35	358	40	116 × 165	NT	1.9	E50.R16-155NT0	3 / FB8
1500	1.5	2.3	60	6.4	19	368	60	85 × 252	NT	1.6	E50.N25-155NT0	5 / FB10
2190	0.55	1.7	100	17.6	53	537	50	116 × 230	NT	2.5	E50.R23-225NT0	3 / FB9
2920	0.59	1.3	100	23.4	70	715	70	116 × 295	NT	3.2	E50.R29-295NT0	3 / FB10
3700	0.79	1.1	100	18	54	907	70	116 × 345	NT	3.5	E50.R34-375NT0	3 / FB15
4200	0.61	1.1	120	30	90	1029	70	136 × 295	NT	4.5	E50.S29-425NT0	2 / FB11
5200	0.68	0.9	120	25	75	1274	70	136 × 345	NT	5.3	E50.S34-525NT0	2 / FB13

PK16 XI™

DATA CHARTS_ DATENTABELLEN_ E50.***PK16 XI™

Other values and dimensions available on request.
Andere Werte und Abmessungen auf Anfrage erhältlich.



E50.***PK16XI™
DC
900...1100V

PK16 XI™

C _N (µF)	R _S (mΩ)	R _{th} (K/W)	I _{max} (A)	Î (kA)	I _S (kA)	E _N (Ws)	L _e (nH)	D ₁ × L ₁ (mm)	Design	m (kg)	order no. Bestell-Nr.	pcs / Box Stk / Box
U_N 900V DC		U_S 1350V		U_r 200V		U_{BB} 1350V DC		U_{BG} 3360V AC/2s				
340	0.85	5.2	60	5.6	16.8	138	60	85 × 100	NT	0.7	E50.N11-344NT0	10 / FB10
355	1	4.7	60	3.9	11.7	144	40	75 × 136	NT7	0.7	E50.M13-364NT7	5 / FB8
425	1.1	4.2	60	3.9	11.7	172	40	75 × 155	NT7	0.75	E50.M15-434NT7	5 / FB8
515	0.92	4.2	60	5.6	16.8	209	40	85 × 136	NT7	0.8	E50.N13-524NT7	5 / FB8
600	0.4	3.5	80	9.9	29.7	243	40	116 × 110	NT	1.2	E50.R11-604NT1	6 / FB10
610	1.1	3.7	60	5.6	16.8	247	40	85 × 155	NZ	0.9	E50.N15-614NZ0	5 / FB8
795	0.93	2.9	60	7.3	21.9	322	60	100 × 165	N57	1.35	E50.Q16-804N57	3 / FB8
900	1.3	2.7	60	5.7	17.1	365	60	85 × 210	NZ	1.25	E50.N21-904NZ0	5 / FB9
1120	0.57	2.3	80	10.3	30.9	454	40	116 × 165	NT	1.9	E50.R16-115NT0	3 / FB8
1150	1.6	2.3	60	5.7	17.1	466	60	85 × 252	NT	1.6	E50.N25-125NT0	5 / FB9
1190	0.88	2.1	80	10.9	32.7	482	60	100 × 230	N57	1.9	E50.Q23-125N57	3 / FB9
1680	0.57	1.7	100	15.4	46.2	680	50	116 × 230	NT	2.5	E50.R23-175NT0	3 / FB9
2240	0.61	1.3	100	20.5	61.5	907	70	116 × 295	NT	3.2	E50.R29-225NT0	3 / FB10
2800	0.78	1.1	100	15.4	46.2	1134	70	116 × 345	NT	3.5	E50.R34-285NT0	3 / FB15
3200	0.57	1.1	120	30	90	1296	70	136 × 295	NT	4.5	E50.S29-325NT0	2 / FB11
4000	0.7	0.9	120	22	66	1620	70	136 × 345	NT	5.3	E50.S34-405NT0	2 / FB13
U_N 1100V DC		U_S 1650V		U_r 250V		U_{BB} 1650V DC		U_{BG} 3840V AC/2s				
255	1.1	4.7	60	3.3	9.9	154	40	75 × 136	NT7	0.7	E50.M13-264NT7	5 / FB8
305	1.2	4.2	60	3.3	9.9	185	40	75 × 155	NT7	0.75	E50.M15-314NT7	5 / FB8
370	0.97	4.2	60	4.7	14.1	224	40	85 × 136	NT7	0.8	E50.N13-374NT7	5 / FB8
450	1.1	3.7	60	4.8	14.4	272	45	85 × 155	NT	1	E50.N15-454NT0	5 / FB8
450	0.46	3.5	80	8.8	26.4	272	40	116 × 110	NT	1.2	E50.R11-454NT0	6 / FB10
570	0.97	2.9	60	6.1	18.3	345	60	100 × 165	N57	1.35	E50.Q16-574N57	3 / FB8
580	0.45	3.1	80	9.1	27.3	351	40	116 × 129	NT	1.4	E50.R12-584NT1	6 / FB10
650	1.3	2.7	60	4.8	14.4	393	60	85 × 210	NZ	1.3	E50.N21-654NZ0	5 / FB9
800	0.61	2.3	80	8.6	25.8	484	40	116 × 165	NT	1.9	E50.R16-804NT0	3 / FB8
830	1.7	2.3	60	4.8	14.4	502	60	85 × 252	NT	1.6	E50.N25-834NT0	5 / FB10
855	0.91	2.1	80	9.2	27.6	517	60	100 × 230	N57	1.9	E50.Q23-864N57	3 / FB9
1200	0.6	1.7	100	13	39	726	50	116 × 230	NT	2.5	E50.R23-125NT0	3 / FB9
1600	0.63	1.3	100	17.2	51.6	968	70	116 × 295	NT	3.2	E50.R29-165NT0	3 / FB10
2000	0.82	1.1	100	12.9	38.7	1210	70	116 × 345	NT	3.5	E50.R34-205NT0	3 / FB15
2300	0.59	1.1	120	24.8	74.4	1392	70	136 × 295	NT	4.5	E50.S29-235NT0	2 / FB11
2900	0.73	0.9	120	18.7	56.1	1755	70	136 × 345	NT	5.3	E50.S34-295NT0	2 / FB13

Other values and dimensions available on request.
Andere Werte und Abmessungen auf Anfrage erhältlich.



E50.***PK16XI™
DC
1300...1800V

PK16 XI™

C _N (µF)	R _S (mΩ)	R _{th} (K/W)	I _{max} (A)	Î (kA)	I _S (kA)	E _N (Ws)	L _e (nH)	D ₁ × L ₁ (mm)	Design	m (kg)	order no. Bestell-Nr.	pcs / Box Stk / Box
U_N 1300V DC		U_S 1950V			U_r 300V		U_{BB} 1950V DC		U_{BG} 4320V AC/2s			
175	1.2	4.7	60	2.8	8.4	148	40	75 × 136	NT7	0.7	E50.M13-184NT7	5 / FB8
205	1.3	4.2	60	2.7	8.1	173	40	75 × 155	NT7	0.75	E50.M15-214NT7	5 / FB8
250	1	4.2	60	4	12	211	40	85 × 136	NT7	0.8	E50.N13-254NT7	5 / FB8
300	1.2	3.7	60	4	12	254	40	85 × 155	NT	1	E50.N15-304NT0	5 / FB8
385	1	2.9	60	5.1	15.3	325	60	100 × 165	N57	1.35	E50.Q16-394N57	3 / FB8
430	1.5	2.7	60	4	12	363	60	85 × 210	NZ	1.25	E50.N21-434NZ0	5 / FB9
545	0.62	2.3	80	7.2	21.6	461	40	116 × 165	NT	1.9	E50.R16-554NT0	3 / FB8
560	1.8	2.3	60	4	12	473	60	85 × 252	NT	1.6	E50.N25-564NT0	5 / FB9
575	0.95	2.1	80	7.6	22.8	486	60	100 × 230	N57	1.9	E50.Q23-584N57	3 / FB9
820	0.6	1.7	100	10.9	32.7	693	50	116 × 230	NT	2.5	E50.R23-824NT0	3 / FB9
1090	0.63	1.4	100	14.5	43.5	946	60	116 × 295	NT	3.2	E50.R29-115NT0	3 / FB10
1370	0.83	1.1	100	10.9	32.7	1158	70	116 × 345	NT	3.5	E50.R34-145NT0	3 / FB15
1560	0.59	1.1	120	20.7	62.1	1318	70	136 × 295	NT	4.5	E50.S29-165NT0	2 / FB11
1950	0.74	0.9	120	15.5	46.5	1648	70	136 × 345	NT	5.3	E50.S34-205NT0	2 / FB13
U_N 1500V DC		U_S 2250V			U_r 300V		U_{BB} 2250V DC		U_{BG} 4800V AC/2s			
135	1.3	4.7	60	2.4	7.2	152	40	75 × 136	NT7	0.7	E50.M13-144NT7	5 / FB8
160	1.4	4.2	60	2.4	7.2	180	40	75 × 155	NT7	0.75	E50.M15-164NT7	5 / FB8
195	1.1	4.2	60	3.5	10.5	219	40	85 × 136	NT7	0.8	E50.N13-204NT7	5 / FB8
230	1.3	3.7	60	3.4	10.2	259	40	85 × 155	NT	1	E50.N15-234NT0	5 / FB8
300	1.1	2.9	60	4.5	13.5	338	60	100 × 165	N57	1.35	E50.Q16-304N57	3 / FB8
330	1.7	2.7	60	3.4	10.2	371	60	85 × 210	NZ	1.25	E50.N21-334NZ0	5 / FB9
380	1.8	2.5	60	3.4	10.2	428	60	85 × 232	NT	1.5	E50.N23-384NT0	5 / FB9
410	0.67	2.3	80	6.1	18.3	461	40	116 × 165	NT	1.9	E50.R16-414NT0	3 / FB8
450	0.98	2.1	80	6.7	20.1	506	60	100 × 230	N57	1.9	E50.Q23-454N57	3 / FB9
615	0.63	1.7	100	9.2	27.6	692	50	116 × 230	NT	2.5	E50.R23-624NT0	3 / FB9
820	0.66	1.4	100	12.2	36.6	922	60	116 × 295	NT	3.2	E50.R29-824NT0	3 / FB10
1020	0.88	1.1	100	9.1	27.3	1148	70	116 × 345	NT	3.5	E50.R34-105NT0	3 / FB15
1170	0.61	1.1	120	17.4	52.2	1316	70	136 × 295	NT	4.5	E50.S29-125NT0	2 / FB11
1490	0.77	0.9	120	13.3	39.9	1676	70	136 × 345	NT	5.3	E50.S34-155NT0	2 / FB13
U_N 1800V DC		U_S 2700V			U_r 400V		U_{BB} 2700V DC		U_{BG} 5520V AC/2s			
160	1.4	3.7	50	2.9	8.7	259	40	85 × 155	NZ	1	E50.N15-164NZ0	5 / FB8
240	1.8	2.7	60	3	9	389	60	85 × 210	NZ	1.25	E50.N21-244NZ0	5 / FB9
275	1.9	2.5	60	2.9	8.7	446	60	85 × 232	NT	1.5	E50.N23-284NT0	5 / FB9
295	0.72	2.3	80	5.3	15.9	478	40	116 × 165	NT	1.9	E50.R16-304NT0	3 / FB8
420	0.68	1.7	100	7.5	22.5	680	50	116 × 230	NT	2.5	E50.R23-424NT0	3 / FB9
590	0.68	1.4	120	10.5	31.5	956	60	116 × 295	NT	3.2	E50.R29-594NT0	3 / FB10
740	0.94	1.1	120	7.9	23.7	1199	70	116 × 345	NT	3.5	E50.R34-744NT0	3 / FB15
840	0.63	1.1	120	15	45	1361	70	136 × 295	NT	4.5	E50.S29-844NT0	2 / FB11
1060	0.82	0.9	120	11.3	33.9	1717	70	136 × 345	NT	5.3	E50.S34-115NT0	2 / FB13



E50.***PK16XI™
DC
2000...2600V

PK16 XI™

C _N (μF)	R _s (mΩ)	R _{th} (K/W)	I _{max} (A)	Î (kA)	I _s (kA)	E _N (Ws)	L _e (nH)	D ₁ × L ₁ (mm)	Design	m (kg)	order no. Bestell-Nr.	pcs / Box Stk / Box
U _N 2000V DC		U _s 3000V		U _r 500V		U _{BB} 3000V DC		U _{BG} 6000V AC/2s				
125	1.5	3.7	50	2.5	7.5	250	40	85 × 155	NZ	1	E50.N15-134NZ0	5 / FB8
180	2	2.7	60	2.5	7.5	360	60	85 × 210	NZ	1.25	E50.N21-184NZ0	5 / FB9
210	2.1	2.5	60	2.5	7.5	420	60	85 × 232	NT	1.5	E50.N23-214NT0	5 / FB9
225	0.78	2.3	80	4.5	13.5	450	40	116 × 165	NT	1.9	E50.R16-234NT0	3 / FB8
335	0.71	1.7	100	6.8	20.4	670	50	116 × 230	NT	2.5	E50.R23-344NT0	3 / FB9
450	0.71	1.4	120	9.1	27.3	900	60	116 × 295	NT	3.2	E50.R29-454NT0	3 / FB10
560	1	1.1	120	6.8	20.4	1120	70	116 × 345	NT	3.5	E50.R34-564NT0	3 / FB15
640	0.65	1.1	120	12.9	38.7	1280	70	136 × 295	NT	4.5	E50.S29-644NT0	2 / FB11
800	0.86	0.9	120	9.6	28.8	1600	70	136 × 345	NT	5.3	E50.S34-804NT0	2 / FB13
U _N 2200V DC		U _s 3300V		U _r 600V		U _{BB} 3300V DC		U _{BG} 6480V AC/2s				
100	1.2	3.7	50	2.2	6.6	242	40	85 × 155	NZ	1	E50.N15-104NZ0	5 / FB8
145	2.1	2.7	60	2.2	6.6	351	60	85 × 210	NZ	1.25	E50.N21-154NZ0	5 / FB9
170	1.8	2.5	60	2.3	6.9	411	60	85 × 232	NT	1.5	E50.N23-174NT0	5 / FB9
180	0.83	2.3	80	4	12	436	40	116 × 165	NT	1.9	E50.R16-184NT0	3 / FB8
270	0.74	1.7	100	6.1	18.3	654	50	116 × 230	NT	2.5	E50.R23-274NT0	3 / FB9
360	0.74	1.4	120	8.1	24.3	871	60	116 × 295	NT	3.2	E50.R29-364NT0	3 / FB10
460	1	1.1	120	6.2	18.6	1113	70	116 × 345	NT	3.5	E50.R34-464NT0	3 / FB15
520	0.66	1.1	120	11.7	35.1	1258	70	136 × 295	NT	4.5	E50.S29-524NT0	2 / FB11
660	0.89	0.9	120	8.9	26.7	1598	70	136 × 345	NT	5.3	E50.S34-664NT0	2 / FB13
U _N 2400V DC		U _s 3600V		U _r 600V		U _{BB} 3600V DC		U _{BG} 6960V AC/2s				
75	1.2	3.7	50	4	12	216	40	85 × 155	NT	1	E50.N15-753NT0	5 / FB8
110	1.5	2.7	60	4	12	317	60	85 × 210	NZ	1.25	E50.N21-114NZ0	5 / FB9
130	1.6	2.5	60	4	12	374	60	85 × 232	NT	1.5	E50.N23-134NT0	5 / FB9
135	0.63	2.3	80	7.2	21.6	389	40	116 × 165	NT	1.9	E50.R16-144NT0	3 / FB8
200	0.61	1.7	100	10.6	31.8	576	50	116 × 230	NT	2.5	E50.R23-204NT1	3 / FB9
270	0.64	1.4	100	14.4	43.2	778	60	116 × 295	NT	3.2	E50.R29-274NT0	3 / FB10
350	0.81	1.1	100	11	33	1008	70	116 × 345	NT	3.5	E50.R34-354NT0	3 / FB15
390	0.59	1.1	120	20.8	62.4	1123	70	136 × 295	NT	4.5	E50.S29-394NT0	2 / FB11
500	0.73	0.9	120	15.6	46.8	1440	70	136 × 345	NT	5.3	E50.S34-504NT0	2 / FB13
U _N 2600V DC		U _s 3900V		U _r 600V		U _{BB} 3900V DC		U _{BG} 7440V AC/2s				
70	1.2	3.7	50	3.9	11.7	237	40	85 × 155	NT	1	E50.N15-703NT0	5 / FB8
100	1.5	2.7	60	3.8	11.4	338	60	85 × 210	NZ	1.25	E50.N21-104NZ0	5 / FB9
120	1.6	2.5	60	3.9	11.7	406	60	85 × 232	NT	1.5	E50.N23-124NT0	5 / FB9
125	0.64	2.3	80	7	21	422	40	116 × 165	NT	1.9	E50.R16-134NT0	3 / FB8
185	0.62	1.7	100	10.4	31.2	625	50	116 × 230	NT	2.5	E50.R23-194NT0	3 / FB9
250	0.64	1.4	100	14	42	845	60	116 × 295	NT	3.2	E50.R29-254NT0	3 / FB10
320	0.82	1.1	100	10.5	31.5	1082	70	116 × 345	NT	3.5	E50.R34-324NT0	3 / FB15
360	0.6	1.1	120	20.2	60.6	1217	70	136 × 295	NT	4.5	E50.S29-364NT0	2 / FB11
460	0.74	0.9	120	15.1	45.3	1555	70	136 × 345	NT	5.3	E50.S34-464NT0	2 / FB13

Other values and dimensions available on request.
Andere Werte und Abmessungen auf Anfrage erhältlich.



E50.***PK16XI™
DC
2800...3600V

PK16 XI™

C_N (μ F)	R_s (m Ω)	R_{th} (K/W)	I_{max} (A)	\hat{I} (kA)	I_s (kA)	E_N (Ws)	L_e (nH)	$D_1 \times L_1$ (mm)	Design	m (kg)	order no. Bestell-Nr.	pcs / Box Stk / Box
U_N 2800V DC		U_S 4200V		U_r 600V		U_{BB} 4200V DC		U_{BG} 7920V AC/2s				
60	1.3	3.7	50	3.6	10.8	235	40	85 × 155	NT	1	E50.N15-603NT0	5 / FB8
100	1.7	2.5	60	3.5	10.8	392	60	85 × 232	NT	1.5	E50.N23-104NT0	5 / FB9
110	0.66	2.3	80	6.6	19.8	431	40	116 × 165	NT	1.9	E50.R16-114NT0	3 / FB8
165	0.63	1.7	100	9.9	29.7	647	50	116 × 230	NT	2.5	E50.R23-174NT0	3 / FB9
220	0.65	1.4	100	13.2	39.6	862	60	116 × 295	NT	3.2	E50.R29-224NT0	3 / FB10
275	0.85	1.1	100	9.7	29.1	1078	70	116 × 345	NT	3.5	E50.R34-284NT0	3 / FB15
310	0.61	1.1	120	18.6	55.8	1215	70	136 × 295	NT	4.5	E50.S29-314NT0	2 / FB11
390	0.76	0.9	120	13.7	41.1	1529	70	136 × 345	NT	5.3	E50.S34-394NT0	2 / FB13
U_N 3000V DC		U_S 4500V		U_r 600V		U_{BB} 4500V DC		U_{BG} 8400V AC/2s				
53	1.3	3.7	50	3.3	9.9	239	40	85 × 155	NT	1	E50.N15-533NT0	5 / FB8
92	1.8	2.5	60	3.4	10.2	414	60	85 × 232	NT	1.5	E50.N23-923NT0	5 / FB9
96	0.69	2.3	80	6.0	18	432	40	116 × 165	NT	1.9	E50.R16-963NT0	3 / FB8
145	0.64	1.7	100	9.1	27.3	653	50	116 × 230	NT	2.5	E50.R23-154NT0	3 / FB9
192	0.66	1.4	100	12.1	36.3	864	60	116 × 295	NT	3.2	E50.R29-194NT0	3 / FB10
245	0.87	1.1	100	9	27	1103	70	116 × 345	NT	3.5	E50.R34-254NT0	3 / FB15
275	0.61	1.1	120	17.3	51.9	1238	70	136 × 295	NT	4.5	E50.S29-284NT0	2 / FB11
355	0.77	0.9	120	13.1	39.3	1598	70	136 × 345	NT	5.3	E50.S34-364NT0	2 / FB13
U_N 3200V DC		U_S 4800V		U_r 700V		U_{BB} 4800V DC		U_{BG} 8880V AC/2s				
37.5	1.3	3.7	50	2.7	8.1	192	40	85 × 155	NT	1	E50.N15-383NT0	5 / FB8
66.5	1.7	2.5	60	2.8	8.4	341	60	85 × 232	NT	1.5	E50.N23-673NT0	5 / FB9
72	0.66	2.3	80	5.2	15.6	369	40	116 × 165	NT	1.9	E50.R16-723NT0	3 / FB8
108	0.63	1.7	100	7.8	23.4	553	50	116 × 230	NT	2.5	E50.R23-114NT0	3 / FB9
144	0.66	1.4	100	10.4	31.2	737	60	116 × 295	NT	3.2	E50.R29-144NT0	3 / FB10
185	0.84	1.1	100	7.9	23.7	947	70	116 × 345	NT	3.5	E50.R34-194NT0	3 / FB11
205	0.62	1.1	120	14.9	44.7	1050	70	136 × 295	NT	4.5	E50.S29-214NT0	2 / FB11
263	0.75	0.9	120	11.2	33.6	1347	70	136 × 345	NT	5.3	E50.S34-264NT0	2 / FB13
U_N 3600V DC		U_S 5400V		U_r 850V		U_{BB} 5400V DC		U_{BG} 9840V AC/2s				
29	1.4	3.7	50	2.4	7.2	188	40	85 × 155	NT	1	E50.N15-293NT0	5 / FB8
50	1.9	2.5	60	2.4	7.2	324	60	85 × 232	NT	1.5	E50.N23-503NT0	5 / FB9
57	0.67	2.3	80	4.7	14.1	369	40	116 × 165	NT	1.9	E50.R16-573NT0	3 / FB8
85.5	0.65	1.7	100	7	21	554	50	116 × 230	NT	2.5	E50.R23-863NT0	3 / FB9
114	0.68	1.4	100	9.4	28.2	739	60	116 × 295	NT	3.2	E50.R29-114NT0	3 / FB10
142	0.88	1.1	100	6.8	20.4	920	70	116 × 345	NT	3.5	E50.R34-144NT0	3 / FB11
160	0.63	1.1	120	13.2	39.6	1037	70	136 × 295	NT	4.5	E50.S29-164NT0	2 / FB11
202	0.78	0.9	120	9.7	29.1	1309	70	136 × 345	NT	5.3	E50.S34-204NT0	2 / FB13



E50.***PK16 CLASSIC (XC™)
DC
600...900V

for latest edition and updates
check www.powercapacitors.info



PK16 XC™ – Extra Capacitance with High Current Strength_Zusätzliche Kapazität und hohe Stromfestigkeit

PK16 XC™

C _N (µF)	R _s (mΩ)	R _{th} (K/W)	I _{max} (A)	Î (kA)	I _s (kA)	E _N (Ws)	L _e (nH)	D ₁ × L ₁ (mm)	Design	m (kg)	order no. Bestell-Nr.	pcs / Box Stk / Box
U_N 600V DC		U_s 900V		U_r 100V		U_{BB} 900V DC		U_{BG} 3300V AC/2s				
465	2.6	5.8	20	1.9	5.7	84	50	67 × 114	N4	0.4	E50.L11-474N40	10 / FB3
465	1.7	5.8	35	2.2	6.6	84	40	75 × 111	NT	0.6	E50.M11-474NT7	10 / FB10
600	0.78	6	40	3.6	10.8	117	40	85 × 95	NT	0.7	E50.N95-654NT7	10 / FB9
780	1.6	5.2	30	3.7	11	140	60	85 × 110	NT	0.7	E50.N11-784NT0	10 / FB10
1000	1.8	4.2	35	3.7	11	180	55	85 × 136	NT	0.8	E50.N13-105NT0	10 / FB11
1100	1.9	3.9	35	3.7	11	198	40	85 × 146	NZ	0.87	E50.N14-115NZ0	5 / FB8
1430	2.3	3.1	35	3.7	11	257	60	85 × 181	NT	1.2	E50.N18-145NT0	5 / FB8
2245	1.1	2.3	40	6.7	20	404	40	116 × 165	NT	1.9	E50.R16-225NT0	3 / FB8
2595	1.3	2	40	6.7	20	467	50	116 × 190	NT	2.2	E50.R19-265NT0	3 / FB9
2830	0.66	1.8	60	13.4	40	509	50	116 × 215	NT	2.4	E50.R21-285NT0	3 / FB9
2860	1.80	1.6	60	7.4	22	515	100	85 × 348	NT	2.1	E50.N35-295NT0	5 / FB11
4140	0.83	1.3	60	13.4	40	745	70	116 × 295	NT	3.2	E50.R29-415NT0	3 / FB10
5190	0.96	1.1	60	13.4	40	934	70	116 × 345	NT	3.5	E50.R34-525NT0	3 / FB15
5900	0.73	1.1	60	19.2	58	1062	70	136 × 295	NT	4.5	E50.S29-595NT0	2 / FB11
7400	0.84	0.9	60	19.2	58	1332	70	136 × 345	NT	5.3	E50.S34-745NT0	2 / FB13
U_N 700V DC		U_s 1050V		U_r 200V		U_{BB} 1050V DC		U_{BG} 3300V AC/2s				
350	3	5.8	20	1.5	5	86	50	67 × 114	N4	0.4	E50.L11-354N40	10 / FB3
585	1.7	5.2	30	3.2	9.6	143	60	85 × 110	NT	0.7	E50.N11-594NT0	10 / FB10
750	2	4.2	35	3.2	9.6	184	55	85 × 136	NT	0.8	E50.N13-754NT0	10 / FB11
825	2.1	3.9	35	3.3	9.9	202	40	85 × 146	NZ	0.87	E50.N14-834NZ0	5 / FB8
1075	2.5	3.1	35	3.2	9.6	263	60	85 × 181	NT	1.2	E50.N18-115NT0	5 / FB8
1680	1.2	2.3	40	5.9	17.7	412	40	116 × 165	NT	1.9	E50.R16-175NT0	3 / FB8
1945	1.4	2	40	5.9	17.7	477	50	116 × 190	NT	2.2	E50.R19-195NT0	3 / FB9
2120	0.69	1.8	60	11.7	35.1	519	50	116 × 215	NT	2.4	E50.R21-215NT0	3 / FB9
2150	1.8	1.6	60	6.5	19.5	527	100	85 × 348	NT	2.1	E50.N35-225NT0	5 / FB11
3100	0.87	1.3	60	11.7	35.1	760	70	116 × 295	NT	3.2	E50.R29-315NT0	3 / FB10
3890	1	1.1	60	11.8	35	953	70	116 × 345	NT	3.5	E50.R34-395NT0	3 / FB15
4420	0.76	1.1	60	16.7	50.1	1083	70	136 × 295	NT	4.5	E50.S29-445NT0	2 / FB11
5540	0.88	0.9	60	16.7	50.1	1357	70	136 × 345	NT	5.3	E50.S34-555NT0	2 / FB13
U_N 900V DC		U_s 1350V		U_r 200V		U_{BB} 1350V DC		U_{BG} 3360V AC/2s				
270	3.2	5.8	20	1.5	5	109	50	67 × 114	N4	0.4	E50.L11-274N40	10 / FB3
313	1.9	5.8	35	4	12	127	40	75 × 111	NT	0.55	E50.M11-314NT7	10 / FB10
355	2.1	5.1	30	3.9	11.7	144	40	75 × 126	NT7	0.6	E50.M12-364NT7	10 / FB10
395	2.2	4.7	30	3.9	11.7	160	40	75 × 136	NT7	0.7	E50.M13-404NT7	5 / FB8
430	2.4	4.4	30	3.9	11.7	174	45	75 × 146	NT7	0.7	E50.M14-434NT7	5 / FB8
450	1.8	5.2	30	2.8	8.4	182	60	85 × 110	NT	0.7	E50.N11-454NT0	10 / FB10
580	2.1	4.2	35	3	10	235	55	85 × 136	NT	0.8	E50.N13-584NT0	10 / FB11
630	2.3	3.9	35	2.8	8.4	255	40	85 × 146	NZ	0.87	E50.N14-634NZ0	5 / FB8
830	2.7	3.1	35	2.9	8.7	336	60	85 × 181	NT	1.2	E50.N18-834NT0	5 / FB8
840	1.7	3.1	40	3.6	10.8	340	40	100 × 155	N57	1.3	E50.Q15-844N57	3 / FB8

Other values and dimensions available on request.
Andere Werte und Abmessungen auf Anfrage erhältlich.



E50.***PK16 CLASSIC (XC™)
DC
900...1300V

PK16 XC™

C _N (µF)	R _S (mΩ)	R _{th} (K/W)	I _{max} (A)	Î (kA)	I _S (kA)	E _N (Ws)	L _e (nH)	D ₁ × L ₁ (mm)	Design	m (kg)	order no. Bestell-Nr.	pcs / Box Stk / Box
U_N 900V DC		U_S 1350V		U_r 200V		U_{BB} 1350V DC		U_{BG} 3360V AC/2s				
910	1.8	2.9	40	3.6	10.8	369	60	100 × 165	N57	1.35	E50.Q16-914N57	3 / FB8
910	0.9	3.2	50	5	15	369	40	116 × 129	NT	1.4	E50.R12-914NT0	6 / FB10
1290	1.3	2.3	40	5.2	15.6	522	40	116 × 165	NT	1.9	E50.R16-135NT0	3 / FB8
1330	0.9	2.5	50	7.3	21.9	539	40	136 × 129	NT	2	E50.S12-135NT0	2 / FB8
1490	1.5	2	40	5.2	15.6	603	50	116 × 190	NT	2.2	E50.R19-155NT0	3 / FB9
1620	0.73	1.8	75	10.3	30.9	656	50	116 × 215	NT	2.4	E50.R21-165NT0	3 / FB9
1660	1.9	1.6	60	5.7	17.1	672	100	85 × 348	NT	2.1	E50.N35-175NT0	5 / FB11
2380	0.93	1.3	60	10.3	30.9	964	70	116 × 295	NT	3.2	E50.R29-245NT0	3 / FB10
2980	1.1	1.1	60	10.3	30.9	1207	70	116 × 345	NT	3.5	E50.R34-305NT0	3 / FB15
3380	0.8	1.1	60	14.6	43.8	1369	70	136 × 295	NT	4.5	E50.S29-345NT0	2 / FB11
4240	0.93	0.9	60	14.6	43.8	1717	70	136 × 345	NT	5.3	E50.S34-425NT0	2 / FB13
U_N 1100V DC		U_S 1650V		U_r 250V		U_{BB} 1650V DC		U_{BG} 3840V AC/2s				
172	1.3	7.3	35	2.4	7.2	104	40	85 × 78	NT	0.5	E50.N78-174NT0	10 / FB10
195	3.2	5.8	30	1.5	5	118	50	67 × 114	N4	0.4	E50.L11-204N40	10 / FB3
255	2.3	5.1	30	1.6	4.8	154	40	75 × 126	NT7	0.6	E50.M12-264NT7	10 / FB10
285	2.5	4.7	30	1.7	5.1	172	40	75 × 136	NT7	0.7	E50.M13-294NT7	5 / FB8
310	2.7	4.4	30	1.6	4.8	188	45	75 × 146	NT7	0.7	E50.M14-314NT7	5 / FB8
325	1.8	5.2	30	2.4	7.2	197	60	85 × 110	NT	0.7	E50.N11-334NT0	10 / FB10
400	0.74	4.0	50	4.3	12.9	242	40	116 × 95	NT	1.1	E50.R95-404NT0	6 / FB9
420	2	4.2	40	2.5	15	254	40	85 × 136	NT	0.8	E50.N13-424NT0	10 / FB11
455	2.3	3.9	40	2.4	14.8	275	40	85 × 146	NZ	0.87	E50.N14-464NZ0	5 / FB8
595	2.8	3.1	40	2.4	14.8	360	60	85 × 181	NT	1.2	E50.N18-604NT0	5 / FB8
605	1.8	3.1	40	3.1	9.3	366	40	100 × 155	N57	1.3	E50.Q15-614N57	3 / FB8
660	1.9	2.9	40	3.1	9.3	399	60	100 × 165	N57	1.35	E50.Q16-664N57	3 / FB8
710	0.94	3	50	4.6	13.8	430	40	116 × 129	NT	1.4	E50.R12-714NT0	6 / FB10
930	1.3	2.3	40	4.4	13.2	563	40	116 × 165	NT	1.9	E50.R16-934NT0	3 / FB8
1075	1.5	2	40	4.4	13.2	650	50	116 × 190	NT	2.2	E50.R19-115NT0	3 / FB9
1170	0.74	1.8	60	8.7	26.1	708	50	116 × 215	NT	2.4	E50.R21-125NT0	3 / FB9
1190	2	1.6	60	4.8	14.4	720	100	85 × 348	NT	2.1	E50.N35-125NT0	5 / FB11
1700	0.94	1.3	60	8.6	25.8	1029	70	116 × 295	NT	3.2	E50.R29-175NT0	3 / FB10
2150	1.1	1.1	60	8.7	26.1	1301	70	116 × 345	NT	3.5	E50.R34-225NT0	3 / FB15
2440	0.80	1.1	60	12.4	37.2	1476	70	136 × 295	NT	4.5	E50.S29-245NT0	2 / FB11
3060	0.93	0.9	60	12.4	37.2	1851	70	136 × 345	NT	5.3	E50.S34-315NT0	2 / FB13
U_N 1300V DC		U_S 1950V		U_r 300V		U_{BB} 1950V DC		U_{BG} 4320V AC/2s				
125	3.9	5.8	20	1	3	106	50	67 × 114	N4	0.4	E50.L11-134N40	10 / FB3
170	2.7	5.1	30	1.4	4.2	144	40	75 × 126	NT7	0.6	E50.M12-174NT7	10 / FB10
190	2.9	4.7	30	1.4	4.2	161	40	75 × 136	NT7	0.7	E50.M13-194NT7	5 / FB8
210	3	4.4	30	1.4	4.2	177	45	75 × 146	NT7	0.7	E50.M14-214NT7	5 / FB8
215	1.8	5.2	30	2	6	182	60	85 × 110	NT	0.7	E50.N11-224NT0	10 / FB10
270	2.5	4.2	40	2	10	228	55	85 × 136	NT	0.8	E50.N13-274NT0	10 / FB11

Other values and dimensions available on request.
Andere Werte und Abmessungen auf Anfrage erhältlich.



E50.***PK16 CLASSIC (XC™)
DC
1300...1800V

PK16 XC™

C _N (μF)	R _S (mΩ)	R _{th} (K/W)	I _{max} (A)	Î (kA)	I _S (kA)	E _N (Ws)	L _e (nH)	D ₁ × L ₁ (mm)	Design	m (kg)	order no. Bestell-Nr.	pcs / Box Stk / Box
U_N 1300V DC		U_S 1950V			U_r 300V		U_{BB} 1950V DC		U_{BG} 4320V AC/2s			
300	2.6	3.9	40	2	10	253	40	85 × 146	NZ	0.87	E50.N14-304NZ0	5 / FB8
390	3.2	3.1	40	2	10	330	60	85 × 181	NT	1.2	E50.N18-394NT0	5 / FB8
410	2.1	3.1	40	2.6	7.8	346	40	100 × 155	N57	1.3	E50.Q15-414N57	3 / FB8
455	2.2	2.9	40	2.6	7.8	384	60	100 × 165	N57	1.35	E50.Q16-464N57	3 / FB8
605	1.6	2.3	40	3.5	10.5	511	40	116 × 165	NT	1.9	E50.R16-614NT0	3 / FB8
700	1.8	2	40	3.5	10.5	592	50	116 × 190	NT	2.2	E50.R19-704NT0	3 / FB9
760	0.82	1.8	60	7	21	642	50	116 × 215	NT	2.4	E50.R21-764NT0	3 / FB9
780	2.3	1.6	60	3.9	11.7	659	100	85 × 348	NT	2.1	E50.N35-784NT0	5 / FB11
1120	1	1.3	60	7	21	946	70	116 × 295	NT	3.2	E50.R29-115NT1	3 / FB10
1400	1.2	1.1	60	7	21	1183	70	116 × 345	NT	3.5	E50.R34-145NT1	3 / FB15
1600	0.88	1.1	60	10	30	1352	70	136 × 295	NT	4.5	E50.S29-165NT1	2 / FB11
2010	1	0.9	60	10.1	30.3	1699	70	136 × 345	NT	5.3	E50.S34-205NT1	2 / FB13
U_N 1500V DC		U_S 2250V			U_r 300V		U_{BB} 2250V DC		U_{BG} 4800V AC/2s			
100	4.2	5.8	20	1	3	113	50	67 × 114	N4	0.4	E50.L11-104N40	10 / FB3
135	3	5.1	30	1.2	3.6	152	40	75 × 126	NT7	0.6	E50.M12-144NT7	10 / FB10
150	3.2	4.7	30	1.2	3.6	169	40	75 × 136	NT7	0.7	E50.M13-154NT7	5 / FB8
165	3.4	4.4	30	1.2	3.6	186	45	75 × 146	NT7	0.7	E50.M14-174NT7	5 / FB8
165	2.3	5.2	30	1.7	5.1	186	60	85 × 110	NT	0.7	E50.N11-174NT0	10 / FB10
210	2.8	4.2	40	2	10	236	55	85 × 136	NT	0.8	E50.N13-214NT0	10 / FB11
230	2.9	3.9	40	2	10	259	40	85 × 146	NZ	0.87	E50.N14-234NZ0	5 / FB8
300	3.6	3.1	40	2	10	338	60	85 × 181	NT	1.2	E50.N18-304NT0	5 / FB8
320	2.2	3.1	40	2.2	6.6	360	40	100 × 155	N57	1.3	E50.Q15-324N57	3 / FB8
345	2.4	2.9	40	2.2	6.6	388	60	100 × 165	N57	1.35	E50.Q16-354N57	3 / FB8
470	1.7	2.3	40	3.3	10	529	40	116 × 165	NT	1.9	E50.R16-474NT0	3 / FB8
540	2	2	40	3.3	10	608	50	116 × 190	NT	2.2	E50.R19-544NT0	3 / FB9
590	0.88	1.8	60	6.1	18.3	664	50	116 × 215	NT	2.4	E50.R21-594NT0	3 / FB9
600	2.5	1.6	60	3.4	10.2	675	100	85 × 348	NT	2.1	E50.N35-604NT0	5 / FB15
860	1.1	1.3	60	6.1	18.3	968	70	116 × 295	NT	3.2	E50.R29-864NT0	3 / FB10
1080	1.3	1.1	60	6.1	18.3	1215	70	116 × 345	NT	3.5	E50.R34-115NT0	3 / FB15
1240	0.93	1.1	60	8.7	26.1	1395	70	136 × 295	NT	4.5	E50.S29-125NT1	2 / FB11
1550	1.1	0.9	60	8.7	26.1	1744	70	136 × 345	NT	5.3	E50.S34-165NT0	2 / FB13
U_N 1800V DC		U_S 2700V			U_r 400V		U_{BB} 2700V DC		U_{BG} 5520V AC/2s			
120	2.6	5.2	30	1.5	5	194	60	85 × 110	NT	0.7	E50.N11-124NT0	10 / FB10
150	3.1	4.2	40	1.5	5	243	55	85 × 136	NT	0.8	E50.N13-154NT0	10 / FB11
165	3.3	3.9	40	1.5	5	267	40	85 × 146	NZ	0.87	E50.N14-174NZ0	5 / FB8
220	4	3.1	40	1.5	5	356	60	85 × 181	NT	1.2	E50.N18-224NT0	5 / FB8
340	2	2.3	40	2.6	7.8	551	40	116 × 165	NT	1.9	E50.R16-344NT0	5 / FB8
390	2.2	2	40	2.6	7.8	632	50	116 × 190	NT	2.2	E50.R19-394NT0	3 / FB9
425	0.95	1.8	60	5.2	15.6	689	50	116 × 215	NT	2.4	E50.R21-434NT0	3 / FB9
440	2.7	1.6	60	3	9	713	100	85 × 348	NT	2.1	E50.N35-444NT0	5 / FB11

Other values and dimensions available on request.
Andere Werte und Abmessungen auf Anfrage erhältlich.



E50.***PK16 CLASSIC (XC™)
DC
1800...2400V

PK16 XC™

C _N (µF)	R _S (mΩ)	R _{th} (K/W)	I _{max} (A)	Î (kA)	I _S (kA)	E _N (Ws)	L _e (nH)	D ₁ × L ₁ (mm)	Design	m (kg)	order no. Bestell-Nr.	pcs / Box Stk / Box
U_N 1800V DC		U_S 2700V			U_r 400V		U_{BB} 2700V DC		U_{BG} 5520V AC/2s			
625	1.2	1.3	60	5.3	16	1013	70	116 × 295	NT	3.2	E50.R29-634NT0	3 / FB10
785	1.4	1.1	60	5.3	16	1272	70	116 × 345	NT	3.5	E50.R34-794NT0	3 / FB15
900	1	1.1	60	7.6	22.8	1458	70	136 × 295	NT	4.5	E50.S29-904NT0	2 / FB11
1125	1.2	0.9	60	7.6	22.8	1823	70	136 × 345	NT	5.3	E50.S34-115NT1	2 / FB13
U_N 2000V DC		U_S 3000V			U_r 500V		U_{BB} 3000V DC		U_{BG} 6000V AC/2s			
90	2.9	5.2	30	1.2	3.6	180	60	85 × 110	NT	0.7	E50.N11-903NT0	10 / FB10
115	3.5	4.2	40	1.2	3.6	230	55	85 × 136	NT	0.8	E50.N13-124NT0	10 / FB11
125	3.7	3.9	40	1.2	3.6	250	40	85 × 146	NZ	0.87	E50.N14-134NZ0	5 / FB8
165	4.6	3.1	40	1.2	3.6	330	60	85 × 181	NT	1.2	E50.N18-174NT0	5 / FB8
260	2.2	2.3	40	2.3	6.9	520	40	116 × 165	NT	1.9	E50.R16-264NT0	3 / FB8
300	2.5	2	40	2.3	6.9	600	50	116 × 190	NT	2.2	E50.R19-304NT0	3 / FB9
325	1.1	1.8	60	4.5	13.5	650	50	116 × 215	NT	2.4	E50.R21-334NT0	3 / FB9
330	3	1.6	60	2.5	7.5	660	100	85 × 348	NT	2.1	E50.N35-334NT0	5 / FB11
475	1.4	1.3	60	4.5	13.5	950	70	116 × 295	NT	3.2	E50.R29-484NT0	3 / FB10
600	1.7	1.1	60	4.6	13.8	1200	70	116 × 345	NT	3.5	E50.R34-604NT0	3 / FB15
685	1.2	1.1	60	6.5	19.5	1370	70	136 × 295	NT	4.5	E50.S29-694NT0	2 / FB11
855	1.4	0.9	60	6.5	19.5	1740	70	136 × 345	NT	5.3	E50.S34-864NT0	2 / FB13
U_N 2200V DC		U_S 3300V			U_r 600V		U_{BB} 3300V DC		U_{BG} 6480V AC/2s			
135	4.9	3.1	40	1.1	3.3	327	60	85 × 181	NT	1.2	E50.N18-144NT0	5 / FB8
210	2.4	2.3	40	2	6	508	40	116 × 165	NT	1.9	E50.R16-214NT0	3 / FB8
240	2.7	2	40	2	6	581	50	116 × 190	NT	2.2	E50.R19-244NT0	3 / FB9
265	1.1	1.8	60	4.1	12.3	641	50	116 × 215	NT	2.4	E50.R21-274NT0	3 / FB9
270	3.1	1.6	60	2.3	6.9	653	100	85 × 348	NT	2.1	E50.N35-274NT0	5 / FB15
385	1.4	1.3	60	4.1	12.3	932	70	116 × 295	NT	3.2	E50.R29-394NT0	3 / FB10
485	1.7	1.1	60	4.1	12.3	1174	70	116 × 345	NT	3.5	E50.R34-494NT0	3 / FB15
555	1.1	1.1	60	5.9	17.7	1343	70	136 × 295	NT	4.5	E50.S29-564NT0	2 / FB11
695	1.3	0.9	60	5.9	17.7	1682	70	136 × 345	NT	5.3	E50.S34-694NT0	2 / FB13
U_N 2400V DC		U_S 3600V			U_r 600V		U_{BB} 3600V DC		U_{BG} 6960V AC/2s			
160	1.6	2.3	40	3.6	10.8	461	40	116 × 165	NT	1.9	E50.R16-164NT0	3 / FB8
185	1.7	2	40	3.6	10.8	533	50	116 × 190	NT	2.2	E50.R19-194NT0	3 / FB9
200	0.78	1.8	60	7.2	21.6	576	50	116 × 215	NT	2.4	E50.R21-204NT0	3 / FB9
205	2.3	1.6	60	4	12	590	100	85 × 348	NT	2.1	E50.N35-214NT0	5 / FB15
295	1	1.3	60	7.2	21.6	850	70	116 × 295	NT	3.2	E50.R29-304NT0	3 / FB10
370	1.2	1.1	60	7.2	21.6	1066	70	116 × 345	NT	3.5	E50.R34-374NT0	3 / FB15
410	0.89	1.1	60	10	30	1210	70	136 × 295	NT	4.5	E50.S29-414NT0	2 / FB11
530	1	0.9	60	10.3	30.9	1526	70	136 × 345	NT	5.3	E50.S34-534NT0	2 / FB13

DATA CHARTS_DATENTABELLEN_E50.***PK16 XC™

Other values and dimensions available on request.
Andere Werte und Abmessungen auf Anfrage erhältlich.



E50.***PK16 CLASSIC (XC™)

DC

2600...3000V

PK16 XC™

C _N (μF)	R _S (mΩ)	R _{th} (K/W)	I _{max} (A)	I _r (kA)	I _S (kA)	E _N (Ws)	L _e (nH)	D ₁ × L ₁ (mm)	Design	m (kg)	order no. Bestell-Nr.	pcs / Box Stk / Box
U_N 2600V DC		U_S 3900V		U_r 600V		U_{BB} 3900V DC		U_{BG} 7440V AC/2s				
145	1.6	2.3	40	3.4	10.2	490	40	116 × 165	NT	1.9	E50.R16-154NT0	3 / FB8
170	1.8	2	40	3.5	10.5	575	50	116 × 190	NT	2.2	E50.R19-174NT0	3 / FB9
180	0.8	1.8	60	6.9	20.7	608	50	116 × 215	NT	2.4	E50.R21-184NT0	3 / FB9
190	2.3	1.6	60	3.9	11.7	642	100	85 × 348	NT	2.1	E50.N35-194NT0	5 / FB15
270	1.1	1.3	60	7	21	913	70	116 × 295	NT	3.2	E50.R29-274NT0	3 / FB10
340	1.2	1.1	60	7	21	1149	70	116 × 345	NT	3.5	E50.R34-344NT0	3 / FB15
390	0.88	1.1	60	10	30	1318	70	136 × 295	NT	4.5	E50.S29-394NT1	2 / FB11
490	1	0.9	60	10	30	1555	70	136 × 345	NT	5.3	E50.S34-494NT0	2 / FB13
U_N 2800V DC		U_S 4200V		U_r 600V		U_{BB} 4200V DC		U_{BG} 7920V AC/2s				
125	1.7	2.3	40	3.2	9.6	490	40	116 × 165	NT	1.9	E50.R16-134NT1	3 / FB8
150	1.9	2	40	3.3	9.9	588	50	116 × 190	NT	2.2	E50.R19-154NT0	3 / FB9
160	0.82	1.8	60	6.5	19.5	627	50	116 × 215	NT	2.4	E50.R21-164NT0	3 / FB9
165	2.4	1.6	60	3.6	10.8	647	100	85 × 348	NT	2.1	E50.N35-174NT0	5 / FB15
235	1.1	1.3	60	6.5	19.5	921	70	116 × 295	NT	3.2	E50.R29-244NT0	3 / FB10
295	1.3	1.1	60	6.4	19.2	1156	70	116 × 345	NT	3.5	E50.R34-304NT0	3 / FB15
335	0.92	1.1	60	9.2	27.6	1313	70	136 × 295	NT	4.5	E50.S29-344NT0	2 / FB11
425	1.1	0.9	60	9.3	27.9	1666	70	136 × 345	NT	5.3	E50.S34-434NT0	2 / FB13
U_N 3000V DC		U_S 4500V		U_r 600V		U_{BB} 4500V DC		U_{BG} 8400V AC/2s				
115	1.8	2.3	40	3	9	518	40	116 × 165	NT	1.9	E50.R16-124NT0	3 / FB8
135	2	2	40	3.1	9.3	608	50	116 × 190	NT	2.2	E50.R19-144NT0	3 / FB9
140	0.86	1.8	60	6	18	630	50	116 × 215	NT	2.4	E50.R21-144NT0	3 / FB9
145	2.5	1.6	60	3.3	9.9	653	100	85 × 348	NT	2.1	E50.N35-154NT0	5 / FB15
210	1.1	1.3	60	6.1	18.3	945	70	116 × 295	NT	3.2	E50.R29-214NT0	3 / FB10
265	1.3	1.1	60	6.1	18.3	1193	70	116 × 345	NT	3.5	E50.R34-274NT0	3 / FB15
300	0.95	1.1	60	8.7	26.1	1350	70	136 × 295	NT	4.5	E50.S29-304NT0	2 / FB11
380	1.1	0.9	60	8.7	26.1	1710	70	136 × 345	NT	5.3	E50.S34-384NT0	2 / FB13

E50.***PK16 CLASSIC (XC™)
DC
3200...3600V

PK16 XC™

C _N (μF)	R _S (mΩ)	R _{th} (K/W)	I _{max} (A)	Î (kA)	I _S (kA)	E _N (Ws)	L _e (nH)	D ₁ × L ₁ (mm)	Design	m (kg)	order no. Bestell-Nr.	pcs / Box Stk / Box
U _N 3200V DC		U _S 4800V		U _r 700V		U _{BB} 4800V DC		U _{BG} 8880V AC/2s				
84	1.7	2.3	40	2.6	7.8	430	40	116 × 165	NT	1.9	E50.R16-843NT0	3 / FB8
98	1.9	2	40	2.6	7.8	502	50	116 × 190	NT	2.2	E50.R19-983NT0	3 / FB9
103	3.1	1.6	60	2.7	8.1	527	100	85 × 348	NT	2.1	E50.N35-104NT0	5 / FB11
105	1	1.8	60	5.2	15.6	538	50	116 × 215	NT	2.4	E50.R21-114NT0	3 / FB9
155	1.4	1.3	60	5.2	15.6	794	70	116 × 295	NT	3.2	E50.R29-164NT0	3 / FB10
195	1.6	1.1	60	5.2	15.6	998	70	116 × 345	NT	3.5	E50.R34-204NT0	3 / FB11
222	1.1	1.1	60	7.4	22.2	1137	70	136 × 295	NT	4.5	E50.S29-224NT0	2 / FB11
280	1.3	0.9	60	7.4	22.2	1434	70	136 × 345	NT	5.3	E50.S34-284NT0	2 / FB13
U _N 3600V DC		U _S 5400V		U _r 850V		U _{BB} 5400V DC		U _{BG} 9840V AC/2s				
66	1.8	2.3	40	2.3	6.9	428	40	116 × 165	NT	1.9	E50.R16-663NT0	3 / FB8
76	2.1	2	40	2.3	6.9	492	50	116 × 190	NT	2.2	E50.R19-763NT0	3 / FB9
80	2.7	1.6	60	2.4	7.2	518	100	85 × 348	NT	2.1	E50.N35-803NT0	5 / FB11
81	0.88	1.8	60	4.5	13.5	525	50	116 × 215	NT	2.4	E50.R21-813NT0	3 / FB9
120	1.2	1.3	60	4.5	13.5	778	70	116 × 295	NT	3.2	E50.R29-124NT0	3 / FB10
152	1.4	1.1	60	4.6	13.8	985	70	116 × 345	NT	3.5	E50.R34-154NT0	3 / FB11
174	0.96	1.1	60	6.6	19.8	1128	70	136 × 295	NT	4.5	E50.S29-174NT0	2 / FB11
218	1.1	0.9	60	6.5	19.5	1413	70	136 × 345	NT	5.3	E50.S34-224NT0	2 / FB13





Can material Gehäusematerial

- N4 plastic (UL94: V0), filled with solid PU resin
Kunststoff (UL94: V0), gefüllt mit ausgehärtetem Polyurethanharz
- NT/NZ/N57 aluminium, filled with solid PU resin
Aluminium, gefüllt mit ausgehärtetem Polyurethanharz

Base mounting stud Bodenschraube M12

Lid Deckel NT/NZ/N57 plastic (UL94: V0) Kunststoff (UL94: V0)

Terminals Anschlüsse

- N4 internal thread Schraubgewinde M5 × 6 mm (torque: 2 Nm)
- NT/N57 internal thread Schraubgewinde M6 × 10 mm (torque: 4 Nm)

Degree of protection Schutzgrad IP 00

	K	L	Humidity Class Feuchteklasse	I _{max} (Terminals Anschlüsse)
N4	25	16	G	30 A
NZ/NT7/NTø85/N57	36	20	F	80 A
NTø116/136	45	35	F	120 A

Designs

N4

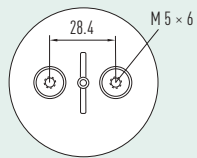
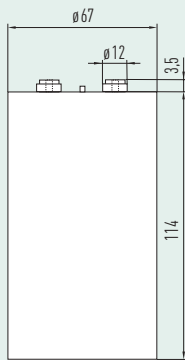

NT7

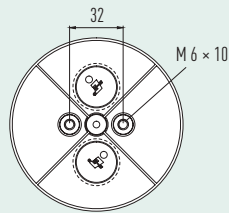
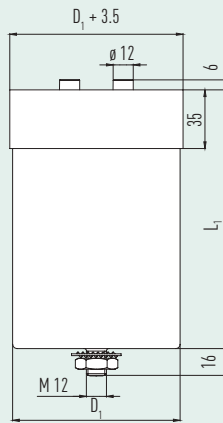

NTø85

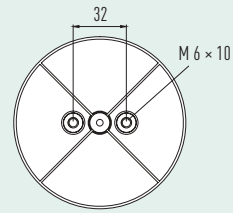
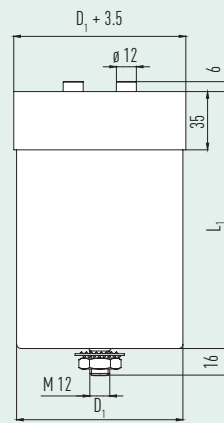

NTø116/136

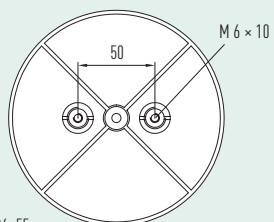
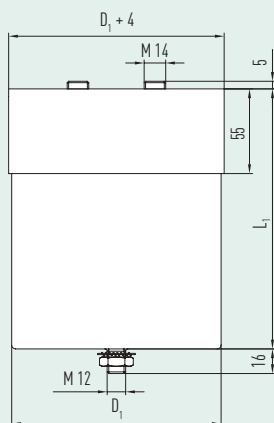

NZ

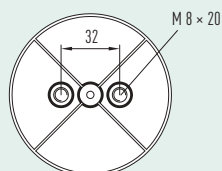
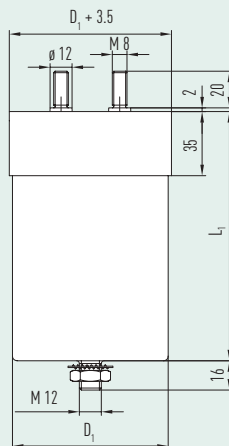

N57

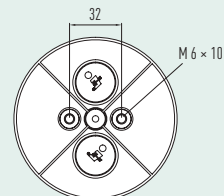
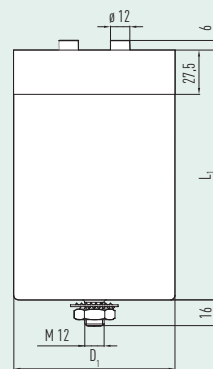

*NTø136: 55





Holding Brackets for PK16

To fulfill specific shock and vibration requirements, tall capacitors may not be sufficiently fixed by their mounting stud alone. These brackets are designed to link capacitors of our PK16 series with diameters of 116 and 136mm with each other and create additional mechanical stabilization during transport and application by anchoring them in the base plate. This construction has been tested successfully for compliance with railway shock and vibration standard IEC EN 61373.

The position of the holders can be arranged at will. Each capacitor should, however, be held by at least two, ideally by three or four brackets which should be allocated as symmetrically as possible. Achieve optimum stability by using the triple brackets for interlinking neighboring capacitor units.

Due to the internal temperature rise, capacitors are subject to slight expansion during operation. Use elastical plastic thread bars only for the link with the base plate to compensate for such expansion. 1m bars, washers and M8 full nuts can be provided as a kit along with the brackets.

Halteklammern für PK16

Um speziellen Anforderungen an die Stoß- und Schwingungsbeständigkeit zu genügen, reicht bei hohen Kondensatoren die Befestigung allein mittels Bodenbolzen u.U. nicht aus. Diese Klammern sind für die Verankerung von PK16-Kondensatoren der Durchmesser 116 und 136 untereinander und mit dem Montageuntergrund gedacht und schaffen zusätzliche Stabilität für Transport und Betrieb. Die Konstruktion wurde erfolgreich nach IEC EN 61373 (Betriebsmittel von Bahnfahrzeugen – Prüfungen für Schwingen und Schocken) getestet.

Die Position der Halter kann nach Belieben gestaltet werden. Jeder Kondensator sollte jedoch mindestens durch zwei, besser drei oder vier, möglichst symmetrisch angeordnete Klammern fixiert werden. Verwenden Sie für optimale Stabilität die Dreier-Klammern, um benachbarte Kondensatoren miteinander zu verbinden.

Infolge Erwärmung dehnen sich Kondensatoren im Betriebszustand etwas aus. Verwenden Sie für die Verankerung in der Grundplatte ausschließlich elastische Zahnstangen aus Kunststoff, um eine solche Ausdehnung auszugleichen. 1-Meter-Zahnstangen, M8-Vollmutter und Zahnscheiben können als Zubehörset geliefert werden.

Drawings Maßbilder

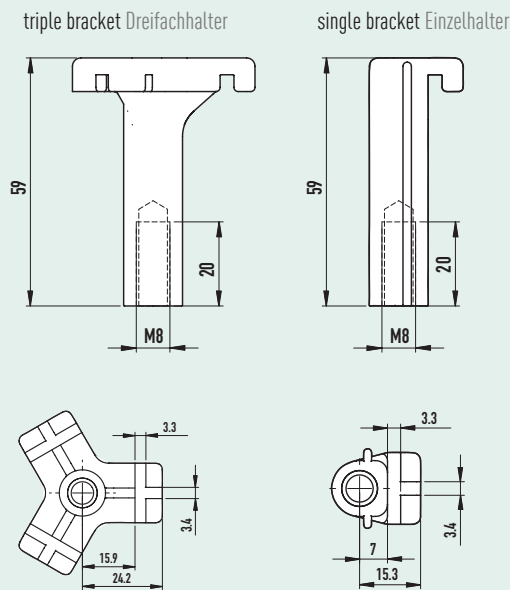

bracket material plastic, UL94-V0
Haltermaterial Kunststoff, UL94-V0
insert (female thread M8) brass
Einsatz (Innengewinde M8) Messing

Optional accessoires:
 plastic thread rod (polyamide 6.6, M8, length 1m)
 hex nut M8 and tooth washer A8.4 (100 sets/box)

Optionales Zubehör:
 Plastikzahnstange (Polyamid 6.6, M8, 1 Meter)
 Sechskantmutter M8 und Zahnscheibe A8.4
 (100 Sets/Karton)

Suggested arrangements Einbauvorschläge

symmetrical installation symmetrische Anordnung

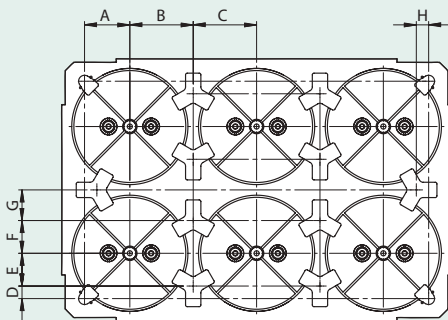

	Ø 116		Ø 136	
	N1	NT	N1	NT
A	46.5	47.5	53.3	54.5
B	64.5	66	74.5	76.3
C	64.5	66	74.5	76.3
D	9.5	10.5	14.8	15.5
E	37	37	38.5	39
F	37	37	38.5	39
G	27.5	29	36	37.3
H	9.5	10.5	14.5	15.8

shifted installation versetzte Anordnung

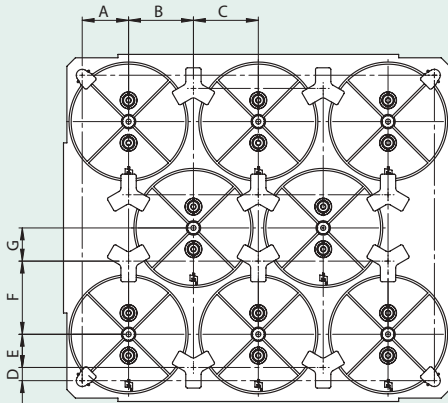

	Ø 116		Ø 136	
	N1	NT	N1	NT
A	46.5	47.5	53.3	54.5
B	64.5	66	74.5	76.3
C	64.5	66	74.5	76.3
D	9.5	10.5	14.8	15.5
E	37	37	38.5	39
F	74.5	76	84.3	86
G	35.5	38	40.8	39



Holder for one capacitor
Halter für einen Kondensator:
material no. 200.520-020003



Holder for three capacitors
Halter für drei Kondensatoren:
material no. 200.520-020004

THE LOW-CAPACITANCE BUFFER CIRCUIT DER KAPAZITÄTSARME ZWISCHENKREIS

3-Phase Frequency converters with Low-Capacitance DC-Link (LCDC)

Robots, elevators, assembly lines, processing centers, tooling machines – high process speed and further improvement of automation levels are unthinkable without frequency controlled AC drives. And it would not be possible to achieve the optimum operating characteristics at an economically feasible utilization level of available resources.

Most of the contemporary 3-phase frequency converters are working with a DC link, mainly using electrolytic capacitors to buffer the DC voltage. When selecting the electrolytic capacitors, the dominating criteria are the AC current load and the required operating life time. As a rule, this leads to the installation of large banks of electrolytic capacitors even though the large capacitance as such would not even be necessary for the buffering as such. These days, decentralized motors with integrated drive are becoming more and more popular. The advantages of this topology are more intelligent and flexible interconnection and control of the individual systems, as well as simplified and more convenient maintenance conditions. At the same time, developers are tasked to improve the technical performance of the electronic drives, reduce their mechanical dimensions and – of course – cost.



The „LCDC“ (DC buffer circuit with low, or small, capacitance) complies with all these requirements and has become possible with the high density DC film capacitors designed and manufactured by ELECTRONICON.

The capacitors of the E61 series are optimized for use in DC Link circuits with high rms and surge currents. The pin terminals allow for direct integration into your printed circuit board.

The winding is placed inside a flame retardant housing filled with solid resin (PUR). In order to minimize self-inductance and dimensions, the E61-capacitors are not equipped with an internal fail-safe device. Capacitors with their comparably high fire load (appr. 40MJ/kg) do always bear a certain risk of collateral damage in the event of a failure. It is therefore necessary to place them in uncritical environment or integrate other proper measures of prevention.

Frequenzumrichter am 3-Netz mit kapazitätsarmem Zwischenkreis

Ob Roboter, Aufzüge, Fertigungsstraßen, Bearbeitungszentren, Werkzeugmaschinen - ohne frequenzgesteuerte Drehstromantriebe sind hohe Prozessgeschwindigkeiten und eine weitere Verbesserung des Automatisierungsgrades nicht zu erreichen. Ebenso wenig wäre es möglich, die optimale Betriebscharakteristik bei einem aus betriebswirtschaftlicher Sicht günstigen Einsatz der vorhandenen Mittel zu erreichen.

Die meisten der heute eingesetzten 3-Netz Frequenzumrichter arbeiten mit einem Gleichspannungszwischenkreis. Zur Pufferung der Gleichspannung werden überwiegend Elektrolyt-Kondensatoren verwendet. Bei deren Dimensionierung sind die Wechselstrombelastung und die geforderte Lebensdauer die entscheidenden Kriterien. Dies führt zumeist zum Einsatz großer Batterien von Elektrolyt-Kondensatoren, obwohl die Gesamtkapazität zur Pufferung gar nicht benötigt wird. Zur Zeit gewinnen dezentral aufgestellte Motoren mit integriertem Antrieb immer mehr an Bedeutung. Die Vorteile dieser Topologie liegen in der flexibleren und intelligenteren Vernetzung und Ansteuerung der einzelnen Systeme, sowie in einem übersichtlicheren Wartungsaufwand. Einhergehend mit dieser Technologie werden an die Entwickler die Forderungen gestellt, die technische Performance der elektronischen Antriebe zu verbessern, die mechanischen Abmaße zu verkleinern und die Kosten zu reduzieren.

Eine Alternative, die allen diesen Forderungen gerecht wird, ist der „Niederkapazitive Gleichspannungszwischenkreis“, welcher dank der von ELECTRONICON entwickelten HD-DC-Kondensatoren möglich wurde.

E61-Kondensatoren sind optimal für die Anwendung in Gleichspannungszwischenkreisen mit hohen Effektiv- und Spitzenströmen. Die Pin-Anschlüsse können zur direkten Montage auf der Leiterplatte genutzt werden. Der Kondensatorwickel ist in einem flammhemmenden Gehäuse untergebracht und mit Harz vergossen. Die Forderung minimierter Eigeninduktivität und Gehäuseabmessungen lässt bei Kondensatoren dieser Bauart keinen integrierten Sicherheitsmechanismus zu. Da Kondensatoren mit ihrer verhältnismäßig hohen Brandlast (ca. 40MJ/kg) im Fehlerfall stets ein gewisses Risiko für Folgeschäden bergen, ist es geboten, sie nur in unkritischer Umgebung oder in Verbindung mit zusätzlichen Vorbeugemaßnahmen zu installieren.

Example

Comparison between a DC link with electrolytic capacitors and film capacitors of our E61 series (5kW drive, $\Theta_{\text{ambient}} = 70^\circ\text{C}$, target life time > 50.000 h):

Beispiel

Vergleich zwischen Gleichspannungszwischenkreisen mit Elektrolyt-Kondensatoren und solchen mit E61-Folienkondensatoren (5kW Umrichter, $\Theta_{\text{Umgebung}} = 70^\circ\text{C}$, angestrebte Lebensdauer > 50.000 h):

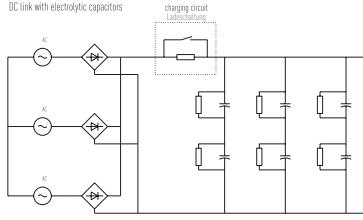
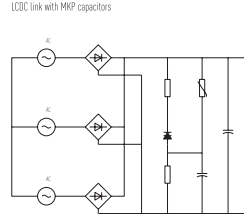
	Elyt* 1300 μF /450V	E61 48 μF /900V
Circuitry	DC link with electrolytic capacitors 	LCDC link with MKP capacitors 
ESR/300Hz	110 m Ω	4.3 m Ω
$I_{\text{rms}}/300\text{Hz}$	8 A	35 A
D x L	40 x 96 mm	50 x 57 mm
Volume per unit Volumen pro Einheit	120 cm ³	112 cm ³
Weight per unit Gewicht pro Einheit	170 g	120 g
Required quantity Benötigte Menge	6	1
Total volume installed Installiertes Gesamtvolumen	6 x 120 cm ³ = 720 cm ³	112 cm ³
Total weight installed Installiertes Gesamtgewicht	6 x 170 g = 1020 g	120 g

* example: market leading manufacturer
* Beispiel: marktführender Hersteller

Interactions with mains

The comparison of mains currents in the graphic to the right shows that the necessity for filtering is substantially reduced as well:

Netrückwirkungen

Die in der Grafik zur rechten dargestellten Netzströme bedürfen hinsichtlich des erforderlichen Filteraufwandes sicher keines Kommentars:

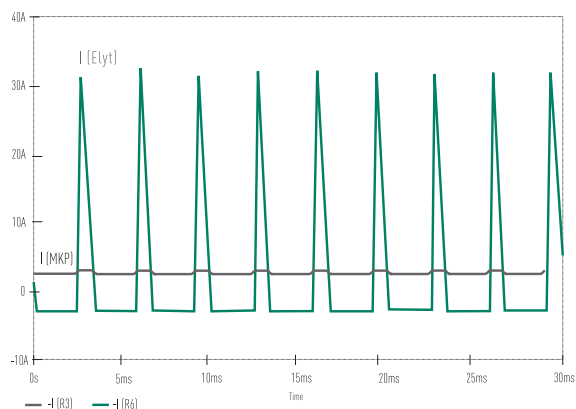

Cost advantages

Presuming that the expenses for the sharing resistors and the charging circuit of the electrolytic capacitors equals more or less the cost of the additional buffering for the MKP circuit, we get a cost reduction by factor 5 when using MKP capacitors instead of electrolytic capacitors. This does not yet consider indirect savings by improved reliability of the final product, reduced power losses a.o.

Kostenvorteil

Unter der Annahme, dass der Aufwand für die Ladeschaltung und die Symmetrierung der Elektrolytkondensatoren etwa genauso hoch ist wie die erforderliche Pufferschaltung beim MKP-Zwischenkreis, ergibt sich eine Kostenreduktion um den Faktor 5 beim Einsatz von MKP-Kondensatoren anstelle von Elektrolytkondensatoren.





Low-inductance DC capacitors for PCB mounting
Niederinduktive DC-Kondensatoren für Leiterplattenmontage



Standards	IEC 61071, optional IEC 61881, UL 810
can Gehäuse	plastic Kunststoff (UL94: V0)
mounting position	optional
Einbaulage	beliebig
filling material	solid, based on vegetable oil, non-PCB
Füllmittel	ausgehärtet, auf Pflanzenölbasis, PCB-frei
internal protection	none
interne Sicherung	keine
fire load Brandlast	40 MJ/kg

C_N tolerance Toleranz	±10%
tanδ₀	2 × 10 ⁻⁴
limit temperatures Grenztemperaturen	
Θ _{min} ... Θ _{max}	-25°C ... +85°C
Θ _{HOTSPOT}	+85°C
storing temperature Lagertemperatur	-40°C ... +85°C
Life time Lebensdauer	> 200 000 h
Failure rate Ausfallrate	50 FIT
(reference service life_Referenzbetriebsdauer 100000 h, Θ _{HOTSPOT} ≤70°C)	



C _N (μF)	R _S (mΩ)	R _{th} (K/W)	I _{max} (A)	Î (kA)	I _S (kA)	E _N (W _S)	L _e (nH)	D ₁ × L ₁ (mm)	Design Maßbild	m (kg)	order no. Bestell-Nr.
U_N 500V DC		U_S 750V		U_r 170 V		U_{BB} 750V DC					
85	2	10.9	35	1.1	3.3	11.9	45	50 × 57	P3	0.12	E61.G57-853P3C
195	3.4	7.4	25	1.1	3.3	24.4	66	50 × 95	P3	0.18	E61.G95-204P3C
190	0.85	7.5	50	2.4	7	23.8	20	75 × 56	P5	0.3	E61.M56-194P50
260	5.2	6.1	30	1.1	3.3	32.5	110	50 × 120	P3	0.21	E61.G12-264P3C
325	0.67	4.7	70	4	12	40.6	25	95 × 56	P5	0.48	E61.P56-334P50
560	1.1	3.4	60	4	12	70	30	95 × 78	P5	0.66	E61.P78-564P50
U_N 700V DC		U_S 1050V		U_r 200V		U_{BB} 1050V DC					
58	1.9	10.9	30	0.9	2.7	14.2	45	50 × 57	P3	0.12	E61.G57-583P3C
142	3.5	7.4	30	0.93	2.8	34.8	66	50 × 95	P3	0.18	E61.G95-144P3C
142	0.92	7.5	50	2.1	6	34.8	20	75 × 56	P5	0.3	E61.M56-144P50
190	4.7	6.1	25	0.91	2.73	46.6	66	50 × 120	P3	0.21	E61.G12-194P3C
240	0.71	4.7	70	4	11	58.8	25	95 × 56	P5	0.48	E61.P56-244P50
415	1.2	3.4	60	4	11	101.7	30	95 × 78	P5	0.66	E61.P78-424P50
U_N 900V DC		U_S 1350V		U_r 260V		U_{BB} 1350V DC					
36	2.4	10.9	35	0.7	2.1	14.6	45	50 × 57	P3	0.12	E61.G57-363P3C
45	2.1	10.9	35	0.8	2.4	18.2	45	50 × 57	P3	0.12	E61.G57-453P3C
48	2.2	10.9	35	0.85	2.55	19.4	45	50 × 57	P3	0.12	E61.G57-483P3C
110	0.98	7.5	45	1.8	5	44.6	20	75 × 56	P5	0.3	E61.M56-114P50
112	4.1	7.4	32	0.84	2.52	43.7	66	50 × 95	P3	0.18	E61.G95-114P3C
155	6	6.1	30	0.85	2.55	62.8	66	50 × 120	P3	0.21	E61.G12-164P3C
187	0.75	4.7	65	3	9	75.7	25	95 × 56	P5	0.48	E61.P56-194P50
325	1.3	3.4	60	3	9	131.6	30	95 × 78	P5	0.66	E61.P78-334P50



C_N (μ F)	R_s (m Ω)	R_{th} (K/W)	I_{max} (A)	\hat{I} (kA)	I_s (kA)	W_N (W $_s$)	L_e (nH)	$D_1 \times L_1$ (mm)	Design Maßbild	m (kg)	order no. Bestell-Nr.
U_N 1100V DC		U_s 1650V		U_r 300V		U_{BB} 1650V DC					
30	2.8	10.9	20	0.64	1.92	18.2	45	50 × 57	P3	0.12	E61.G57-303P3C
73	4.5	7.4	25	0.66	1.98	44	66	50 × 95	P3	0.18	E61.G95-733P3C
82	1.06	7.5	40	1.6	5	49.6	20	75 × 56	P5	0.3	E61.M56-823P50
100	6.1	6.1	25	0.66	1.98	60.5	66	50 × 120	P3	0.21	E61.G12-104P3C
140	0.79	4.7	65	2.7	8	84.7	25	95 × 56	P5	0.48	E61.P56-144P50
240	1.35	3.4	55	2.7	8	145.2	30	95 × 78	P5	0.66	E61.P78-244P50
U_N 1300V DC		U_s 1950V		U_r 300V		U_{BB} 1950V DC					
12	4	10.9	20	0.38	1.14	10	45	50 × 57	P3	0.12	E61.G57-123P3C
16.5	3	10.9	20	0.47	1.41	14	45	50 × 57	P3	0.12	E61.G57-173P3C
40.5	5.7	7.4	25	0.49	1.47	34	66	50 × 95	P3	0.18	E61.G95-413P3C
54	1.21	7.5	40	1.6	5	45.6	20	75 × 56	P5	0.3	E61.M56-543P50
55	7.7	6.1	25	0.49	1.47	46	66	50 × 120	P3	0.21	E61.G12-553P3C
93	0.88	4.7	60	2.2	7	78.6	25	95 × 56	P5	0.48	E61.P56-933P50
160	1.5	3.4	55	2.2	7	135.2	30	95 × 78	P5	0.66	E61.P78-164P50
U_N 2000V DC		U_s 3000V		U_r 400V		U_{BB} 3000V DC					
23	1.54	7.5	35	0.9	2.7	46	20	75 × 56	P5	0.3	E61.M56-233P50
39	1.08	4.7	55	1.5	5	78	25	95 × 56	P5	0.48	E61.P56-393P50
66	1.9	3.4	50	1.4	4	132	30	95 × 78	P5	0.66	E61.P78-663P50
U_N 2200V DC		U_s 3300V		U_r 400V		U_{BB} 3300V DC					
18.5	1.67	7.5	35	0.8	2.4	44.8	20	75 × 56	P5	0.3	E61.M56-193P50
31	1.16	4.7	55	1.3	4	75	25	95 × 56	P5	0.48	E61.P56-313P50
53	2	3.4	45	1.3	4	128.3	30	95 × 78	P5	0.66	E61.P78-533P50
U_N 2600V DC		U_s 3900V		U_r 500V		U_{BB} 3900V DC					
12	1.41	7.5	35	1.3	4	40.6	20	75 × 56	P5	0.3	E61.M56-123P50
20	1.01	4.7	55	2.1	6	67.6	25	95 × 56	P5	0.48	E61.P56-203P50
37	2.1	3.4	45	1	3	125.1	30	95 × 78	P5	0.66	E61.P78-373P50
U_N 3300V DC		U_s 4950V		U_r 700V		U_{BB} 4950V DC					
6.5	1.72	7.5	30	1	2.9	35.4	20	75 × 56	P5	0.3	E61.M56-702P50
11.5	1.15	4.7	45	1.7	5	62.6	25	95 × 56	P5	0.48	E61.P56-123P50
U_N 3600V DC		U_s 5400V		U_r 800V		U_{BB} 5400V DC					
6	1.77	7.5	30	0.9	2.8	38.9	20	75 × 56	P5	0.3	E61.M56-602P50
10	1.23	4.7	45	1.5	5	64.8	25	95 × 56	P5	0.48	E61.P56-103P50
U_N 4000V DC		U_s 6000V		U_r 800V		U_{BB} 6000V DC					
4.5	2.02	7.5	25	0.8	2.3	36	20	75 × 56	P5	0.3	E61.M56-452P50
7.5	1.38	4.7	40	1.3	4	60	25	95 × 56	P5	0.48	E61.P56-752P50





Design P3

Principal circuit diagram P3
Prinzipschaltbild P3

Can material..... flame-retardant plastic can (UL94: V0),
filled with solidified PUR resin

Terminals..... copper wire \varnothing 1.2 mm / 2 mm

I_{max} (Terminals)..... 35 A

Degree of protection IP 00

K 17.5 mm

L 17.5 mm

Humidity class F

Gehäusematerial Flammhemmender Kunststoff (UL94: V0),
gefüllt mit ausgehärtetem Polyurethanharz

Anschlüsse..... Kupferdraht \varnothing 1.2 mm / 2 mm

I_{max} (Anschlüsse) 35 A

Schutzgrad IP 00

K 17.5 mm

L 17.5 mm

Feuchtklasse F

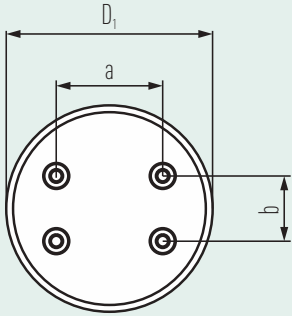

 Design P5

Ø	a	b
75	42.5	25
95	49	30

Principal circuit diagram P5
Prinzipschaltbild P5

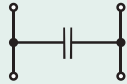

P5 CAPACITORS WITH A CAN DIAMETER OF 75/95 MM

- Can material**.....plastic can, filled with PUR resin
- Fixing**.....can be fixed by terminals on PCB or bus bar
- Terminals**.....internal threads M6i x 5mm
- I_{max} (Terminals)**.....40 A
- Degree of protection**.....IP 00
- K/L**.....Ø 75: 30 mm
Ø 95: 37.5 mm
- Humidity class**.....F

P5 KONDENSATOREN MIT GEHÄUSEDURCHMESSER 75/95 MM

- Gehäusematerial**.....Kunststoff, gefüllt mit ausgehärtetem Polyurethanharz
- Befestigung**.....kann mit Anschlüssen direkt auf Leiterplatte oder Sammelschiene geschraubt werden
- Anschlüsse**.....Innengewinde M6i x 5 mm
- I_{max} (Anschlüsse)**.....40 A
- Schutzgrad**.....IP 00
- K/L**.....Ø 75: 30 mm
Ø 95: 37.5 mm
- Feuchtklasse**.....F



Important Remarks

Safety

ELECTRONICON will not indemnify or be responsible for any kind of damages to persons or property due to the improper application of any capacitors purchased from ELECTRONICON or its distributors.

The capacitors should only be used for the application intended.

Mind that electrical or mechanical misapplication of capacitors can become hazardous. Misapplied capacitors can explode or catch fire and cause bodily injury or property damage due to the expulsion of material or metal fragments.

Please consult the detailed instructions for mounting and application stated in our brochure „Application Notes“ and on the ELECTRONICON website.

If in doubt about how to connect, operate, or discharge a capacitor, consult ELECTRONICON engineering.

Mounting And Cooling

The useful life of a capacitor may be reduced dramatically if exposed to excessive heat. Typically an increase in the ambient temperature of 7°C will halve the expected life of the capacitor. Make sure to obey the permitted operating temperatures.

To avoid overheating the capacitors must be allowed to cool unhindered and should be shielded from external heat sources. We recommend forced ventilation for all applications with detuning reactors.

Give at least 20mm clearance between the capacitors for natural or forced ventilation, and do not place them directly above or next to heat sources such as detuning or tuning reactors, bus bars, etc.

Protection against Overvoltages And Short Circuits:

Self-Healing Dielectric

All dielectric structures used in our power capacitors are „selfhealing“: In the event of a voltage breakdown the metal layers around the breakdown channel are evaporated by the temperature of the electric arc that forms between the electrodes. They are removed within a few microseconds and pushed apart by the pressure generated in the centre of the breakdown spot.

An insulation area is formed which is reliably resistive and voltage proof for all operating requirements of the capacitor. The capacitor remains fully functional during and after the breakdown.

For voltages within the permitted testing and operating limits the capacitors are short-circuit- and overvoltage-proof. They are also proof against external short circuits as far as the resulting surge discharges do not exceed the specified surge current limits.

Wichtige Hinweise

Sicherheit

ELECTRONICON übernimmt keine Verantwortung oder Haftung für jegliche Schäden an Personen oder Eigentum, welche aus der unsachgemäßen Anwendung von bei ELECTRONICON oder seinen Distributoren erworbenen Kondensatoren herrührt.

Die Kondensatoren dürfen ausschließlich für ihren Bestimmungszweck verwendet werden.

Beachten Sie, daß ein elektrisch oder mechanisch fehlerhafter Einsatz von Kondensatoren gefährlich sein kann. Falsch eingesetzte Kondensatoren können explodieren oder Feuer fangen und infolge austretender Materialien bzw. Metallteile gesundheitliche und materielle Schäden verursachen.

Bitte konsultieren Sie die detaillierten Anweisungen in unserer Broschüre „Anwendungshinweise“ sowie auf der Webseite von ELECTRONICON.

Bitte konsultieren Sie das Fachpersonal von ELECTRONICON oder seiner Distributoren bei allen Fragen bezüglich des Anschlusses, der Verwendung oder der Entladung von Kondensatoren.

Montage und Kühlung

Die Lebensdauer eines Kondensators kann durch übermäßige Wärmeeinwirkung erheblich verringert werden. Im allgemeinen führt eine Erhöhung der Umgebungstemperatur um 7°C zu einer Verringerung der Lebensdauer des Kondensators um 50 %. Halten Sie die zugelassenen Betriebstemperaturen ein.

Um Überhitzung zu vermeiden, muß gewährleistet sein, daß die Kondensatoren auftretende Verlustwärme ungehindert abführen können und vor fremden Wärmequellen abgeschirmt werden. Insbesondere bei verdrosselten Anlagen ist in jedem Falle eine Zwangslüftung zu empfehlen. Zwischen den und um die Kondensatoren herum sollten mindestens 20mm Platz für natürliche oder Zwangslüftung belassen werden. Bringen Sie den Kondensator nie direkt neben oder über Wärmequellen, wie Drosseln u. ä. an.

Schutz gegen Überspannungen und Kurzschlüsse: Selbstheilendes Dielektrikum

Alle in unseren Leistungskondensatoren eingesetzten dielektrischen Strukturen sind selbstheilend. Im Falle eines Kurzschlusses (Spannungsdurchschlag) verdampfen die Metallbeläge um den Durchschlagpunkt herum aufgrund der Temperatur des Lichtbogens, der sich zwischen den Elektroden bildet. Innerhalb weniger Mikrosekunden wird der Metaldampf durch den beim Durchschlag entstehenden Überdruck vom Zentrum des Durchschlages weggedrückt. Aus diese Weise bildet sich eine belagfreie Zone rings um den Durchschlagpunkt, wodurch dieser vollständig isoliert wird. Der Kondensator bleibt während und nach dem Durchschlag voll funktionsfähig.

Für Spannungen innerhalb der zugelassenen Test- und Betriebsbedingungen sind die Kondensatoren kurzschluss- und überspannungssicher. Sie sind außerdem sicher gegen äußere Kurzschlüsse, sofern bei den dabei entstehenden Stoßentladungen die zugelassenen Stoßströme nicht überschritten werden.

Failure Rate

The failure probability of a component is a statistical value which is described by a log-normal distribution:

$$N = N_0 \times e^{-\lambda t}$$

Ausfallrate

Die Ausfallwahrscheinlichkeit eines Bauelements ist eine statistische Größe, die mit Hilfe einer Normalverteilung beschrieben wird. Es gilt:

N = number of functional components after period t

Anzahl der nach der Zeit t intakten Bauelemente

N_0 = total number of components at time $t = 0$

Gesamtzahl der Bauelemente zum Zeitpunkt $t = 0$

λ = failure rate Ausfallrate

λ is the failure rate, which alternatively is also stated as the so-called FIT-rate (FIT = Failures In Time = $\lambda \times 10^9$).

Dabei ist λ die Ausfallrate, die alternativ auch als FIT -Rate angegeben wird (FIT = $\lambda \times 10^9$)

The failure rate is very closely linked with operating temperature and operating voltage of the capacitor. The FIT rates stated in this catalogue are related to the capacitors' rated voltage and a dielectric temperature (= HOTSPOT temperature) of 70°C.

Die Ausfallrate ist stark abhängig von der Temperatur und der Betriebsfeldstärke. Die FIT-Raten im Katalogsortiment beziehen sich auf 70°C Dielektrikumtemperatur (=Hotspot-Temperatur) und die Nennspannung des Kondensators.

The simultaneous operation of capacitors at highest permissible voltage and operating temperature should be avoided; otherwise, failure rates may increase beyond reasonable technical reliability.

Der Betrieb von Kondensatoren mit der höchsten zulässigen Spannung und der höchsten zulässigen Betriebstemperatur sollte vermieden werden, andernfalls können die Ausfallraten so hoch werden, dass keine technisch sinnvollen Zuverlässigkeiten mehr gewährleistet sind.

The standard reference period for the failure rate statement is 100.000 hours. Please note that FIT rates can be altered or improved by technical adjustments. Please contact us for details.

Der Wert für die Ausfallrate bezieht sich auf einen Referenzzeitraum von 100.000h. FIT-Raten können durch technische Anpassung der Kondensatoren beeinflusst und verbessert werden. Auskünfte hierzu erteilen wir auf Anfrage.

The following diagram demonstrates the correlation between FIT rate, operating voltages and operating temperatures.

Das nachstehende Kurvendiagramm macht den Zusammenhang von FIT-Rate, Betriebsspannung und Betriebstemperatur deutlich.

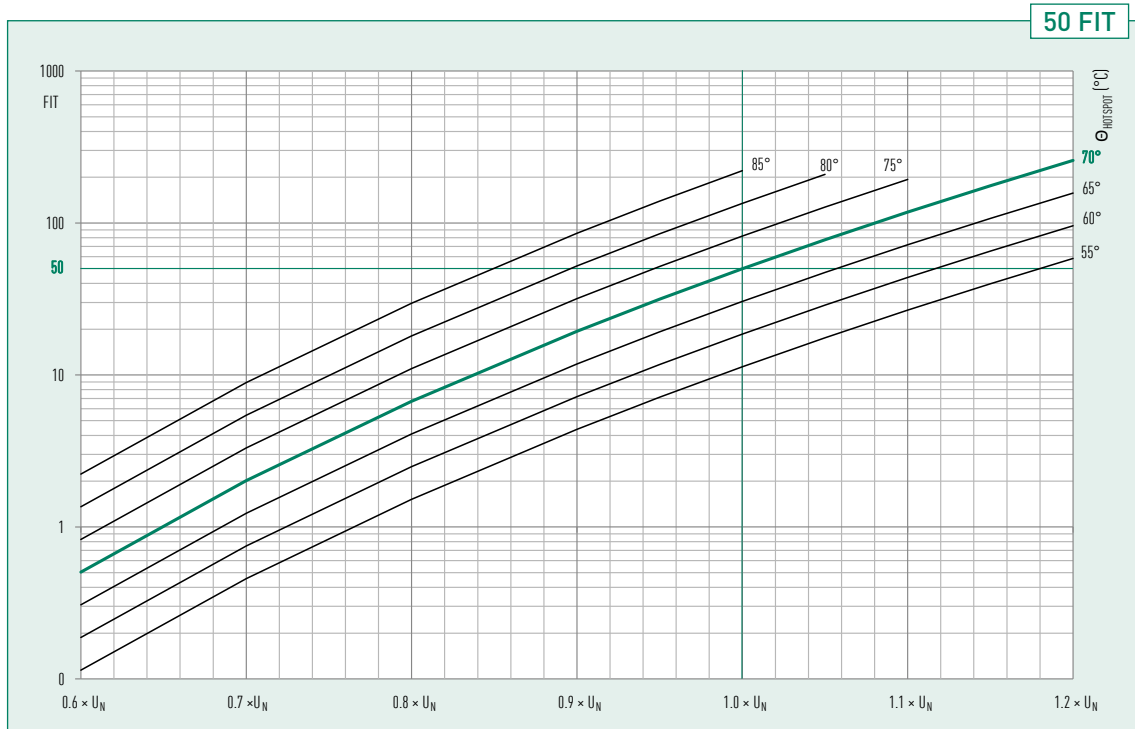

Limited Warranty

All our products are designed, manufactured, and tested with the highest care and workmanship. The satisfaction of our customers is our highest goal. We therefore warrant remedying any defect in the goods resulting from faulty design, materials or workmanship, which appears within 3 years (E61: 2 years) from the date of sale.

This warranty does not cover defects due to improper use of the goods or operation at conditions exceeding the rated values stated in the catalogue or special data sheet. Nor does it cover defects due to faulty maintenance or incorrect installation, alterations or faulty repairs undertaken by the Buyer. Finally the warranty does not cover normal wear and tear or deterioration.

See our „General Conditions“ for details on Warranty and Product liability.

Find more information and detailed instructions in our „Application Notes“ and on www.electronic.com

Gewährleistung

Alle unsere Erzeugnisse werden mit höchster Sorgfalt und Fachkenntnis entwickelt, hergestellt und geprüft. Die Zufriedenheit unserer Kunden ist unser höchstes Ziel. Wir verpflichten uns daher, jeden innerhalb von 3 Jahren (E61: 2 Jahre) ab Verkaufsdatum auftretenden Mangel an unseren Erzeugnissen zu beseitigen, welcher aus Fehlern in Design, Material oder Herstellung herrührt. Diese Gewährleistung erstreckt sich nicht auf Defekte, welche auf unsachgemäße Anwendung oder Betrieb jenseits der nach Katalog oder speziellem Datenblatt zulässigen Einsatzbedingungen zurückzuführen sind. Sie erfaßt ebensowenig Schäden, welche aus fehlerhafter Wartung, unsachgemäßer Montage, Änderungen oder unsachgemäßen Reparaturen durch den Käufer bzw. Anwender resultieren. Schließlich betrifft diese Gewährleistung auch nicht normale Abnutzung und Verschleiß.

Siehe unsere „Allgemeinen Geschäftsbedingungen“ für Details zu Gewährleistung und Produkthaftung.

Mehr Informationen und ausführliche Anweisungen finden Sie in unseren „Anwendungshinweisen“ und unter www.electronic.com



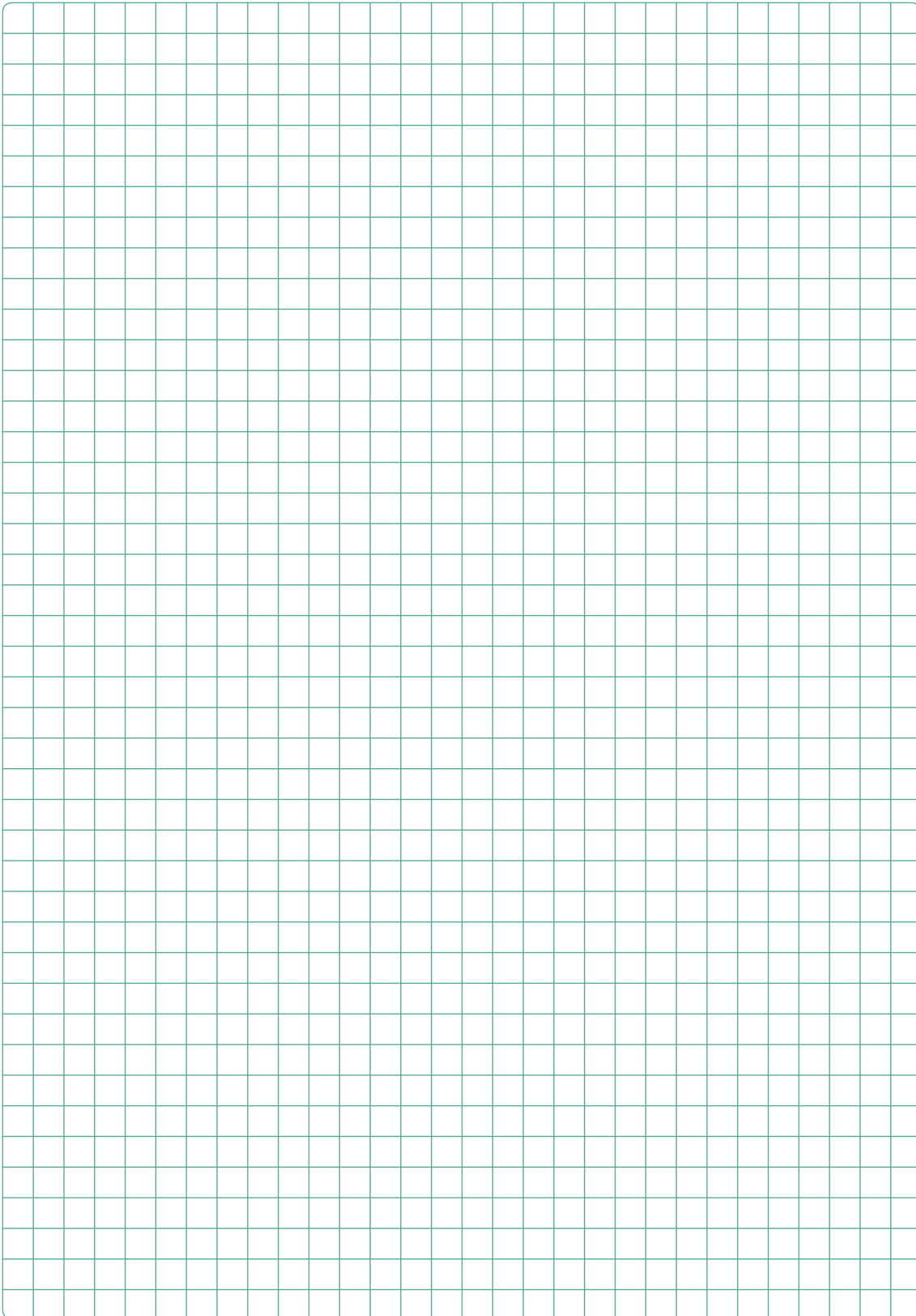

NOTES
NOTIZEN

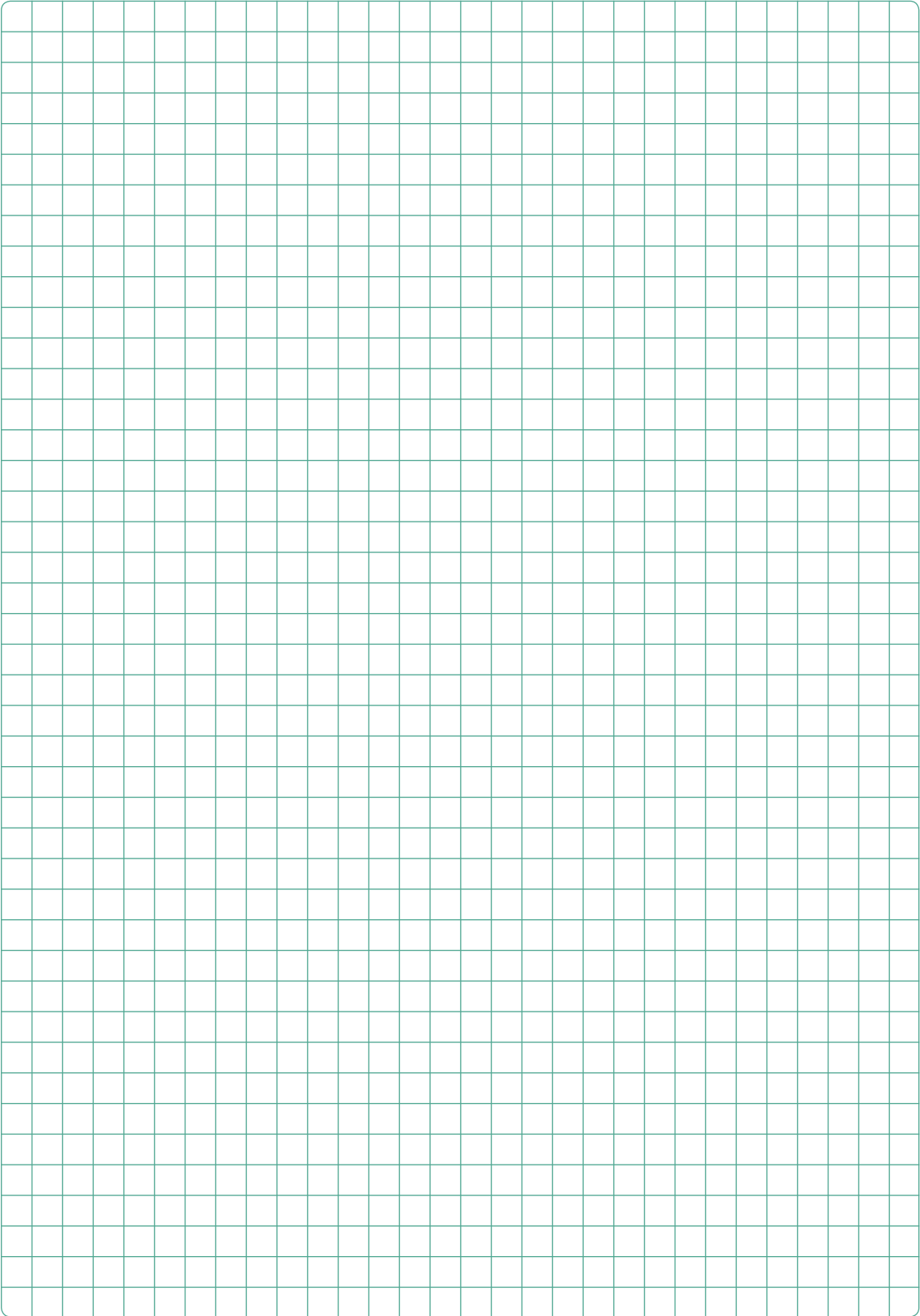

CAPACITORS FOR APPLICATIONS IN POWER ELECTRONICS

www.electronicon.com



E51/E53/E55
AC/DC FILM CAPACITORS



HIGH VOLTAGES, HEAVY CURRENTS, AND LOW INDUCTANCE

ELECTRONICON
always in charge

www.electronicon.com



E57/E59/SR17™ AC AND DC CAPACITORS
WITH LARGE CAPACITANCES



STANDARD OR SPECIAL – YOUR CHOICE

ELECTRONICON
always in charge

www.electronicon.com



PK16™ AND E61
– HIGH DENSITY DC FILM
CAPACITORS



THE IDEAL CHOICE FOR YOUR DC LINK

ELECTRONICON
always in charge

www.electronicon.com



E62 AND E64
HEAVY DUTY AC CAPACITORS



THE PERFECT CHOICE FOR YOUR AC/DC APPLICATION

ELECTRONICON
always in charge

www.electronicon.com



E62-3ph AND 3HF
HEAVY DUTY THREE PHASE AC FILTER CAPACITORS



HIGH-END FOR THE HEART OF YOUR AC FILTER

ELECTRONICON
always in charge

www.electronicon.com



PEC APPLICATION NOTES / ANWENDUNGSHINWEISE



ELECTRONICON
always in charge

always in charge

EXCELLENT EXPERIENCE IN CAPACITOR MAKING FOR OVER 75 YEARS

Gera has been a centre of capacitor making since 1938. ELECTRONICON Kondensatoren GmbH which emerged from previous RFT/VEB ELEKTRONIK Gera in 1992, has become one of Europe's leading capacitor manufacturers supplying customers worldwide and being an open and competent partner for manufacturers and users of power factor correction equipment, for many manufacturers of drives, power electronics, home appliances, and for the lighting industry. Regular investments in advanced and environmentally sound technologies guarantee the highest levels in manufacture and quality to modern standards which are approved and monitored by leading certification authorities.



In today's globalised competition, we distinguish ourselves by

- Absolute reliability and safety of our products
- Close co-operation between manufacturer and client to meet both technical and commercial requirements
- Improvement and development of our technical expertise in capacitor design and manufacture, as well as film coating, with special attention paid to the MKPg-technology
- Early identification and incorporation of new trends and methods in the manufacturing of capacitors
- Flexibility and punctual fulfilment of our commercial obligations

Our experienced development engineers are competent and responsible for both implementing the latest technical trends applicable to our products and ensuring that our products adapt to the challenges of traditional and new markets. The close and intense co-operation between the departments of Marketing & Sales, Research & Development, and Production has become the keystone of our success. ELECTRONICON is continually striving to establish a similarly close and interactive relationship with its distributors and direct clients both in home and overseas markets, to become not just one out of many suppliers, but your preferred partner for ideas and solutions.

ELECTRONICON®

Germany • 07549 Gera • Keplerstrasse 2
Fon +49 365 / 734 61 00 • Fax +49 365 / 734 61 10
E-Mail: sales@electronicon.com, www.electronicon.com

