

OPERATION MANUAL

Torque Sensor Model 8656

© 2023 burster
praezisionsmesstechnik gmbh & co kg
All rights reserved

Valid from 09.02.2023

Manufacturer:

burster	burster
praezisionsmesstechnik gmbh & co kg	praezisionsmesstechnik gmbh & co kg
Talstr. 1 - 5	Talstr. 1 - 5
76593 Gernsbach	76593 Gernsbach
Germany	Germany

Tel.: +49-7224-645-0
Fax.: +49-7224-645-88
Email: info@burster.com
www.burster.com

4357-BA8656EN-5699-021525

Warranty disclaimer

All information in the present documentation was prepared and compiled with great care and reproduced subject to effective control measures. No warranty is provided for freedom from errors. We reserve the right to make technical changes. The present information as well as the corresponding technical data can change without notice. Reproduction of any part of this documentation or its processing or revision using electronic systems is prohibited without the manufacturer's prior written approval.

Components, devices and measured value sensors made by burster praezisionsmesstechnik (hereinafter referred to as "product") are the results of targeted development and meticulous research. As of the date of delivery, burster provides a warranty for the proper condition and functioning of these products covering material and production defects for the period specified in the warranty document accompanying the product. However, burster excludes guarantee or warranty obligations as well as any liability beyond that for consequential damage caused by improper use of the product, in particular the implied warranty of success in the market as well as the suitability of the product for a particular purpose. Furthermore, burster assumes no liability for direct, indirect or incidental damages as well as consequential or other damages arising from the provision and use of the present documentation..



THE MEASUREMENT SOLUTION.

EU-Konformitätserklärung (nach EN ISO/IEC 17050-1:2010) EU-Declaration of conformity (in accordance with EN ISO/IEC 17050-1:2010)

Name des Ausstellers: burster präzisionsmesstechnik gmbh & co kg
Issuer's name:

Anschrift des Ausstellers: Talstr. 1-5
Issuer's address: 76593 Gernsbach, Germany

Gegenstand der Erklärung: Drehmomentsensor
Object of the declaration: Torque Sensor

Modellnummer(n) (Typ): 8655 / 8656
Model number / type:

Diese Erklärung beinhaltet obengenannte Produkte mit allen Optionen
This declaration covers all options of the above product(s)

Das oben beschriebene Produkt ist konform mit den Anforderungen der folgenden Dokumente:
The object of the declaration described above is in conformity with the requirements of the following documents:

Dokument-Nr. <i>Documents No.</i>	Titel <i>Title</i>	Ausgabe <i>Edition</i>
2011/65/EU + delegD (EU) 2015/863	Richtlinie zur Beschränkung der Verwendung bestimmter gefährlicher Stoffe in Elektro- und Elektronikgeräten <i>Directive on the restriction of the use of certain hazardous substances in electrical and electronic equipment</i>	2011 + 2015
2014/35/EU	Richtlinie zur Harmonisierung der Rechtsvorschriften der Mitgliedsstaaten über die Bereitstellung elektrischer Betriebsmittel zur Verwendung innerhalb bestimmter Spannungsgrenzen auf dem Markt <i>Directive on the harmonization of the laws of the Member States relating to the making available on the market of electrical equipment designed for use within certain voltage limits</i>	2014
2014/30/EU	Richtlinie zur Harmonisierung der Rechtsvorschriften der Mitgliedsstaaten über die Elektromagnetische Verträglichkeit <i>Directive on the harmonization of the laws of the Member States relating to electromagnetic compatibility</i>	2014
EN 61326-1	Elektrische Mess-, Steuer-, Regel- und Laborgeräte – EMV-Anforderungen – Teil 1: Allgemeine Anforderungen <i>Electrical equipment for measurement, control and laboratory use – EMC requirements – Part 1: General requirements</i>	2013
EN 61326-2-3	Elektrische Mess-, Steuer-, Regel- und Laborgeräte – EMV-Anforderungen – Teil 2-3: Besondere Anforderungen <i>Electrical equipment for measurement, control and laboratory use – EMC requirements – Part 2-3: Particular requirements</i>	2013

Gernsbach 18.11.2020 ppa. Christian Karius
Ort / place Datum / date Quality Manager

Dieses Dokument ist entsprechend EN ISO/IEC 17050-1:2010 Abs. 6.1g ohne Unterschrift gültig /
According EN ISO/IEC 17050 this document is valid without a signature.

burster präzisionsmesstechnik gmbh & co kg

Talstr. 1-5 · DE-76593 Gernsbach
Tel. (+49) 07224-6450
info@burster.com

Geschäftsführer/Managing Director: Matthias Burster
Handelsregister/Trade Register: Gernsbach
Registergericht/Register Court: Mannheim HRA 530170

Kompl./Gen. Partn.: burster präzisionsmesstechnik Verwaltungs-GmbH
Handelsregister/Trade Register: Gernsbach
Registergericht/Register Court: Mannheim HRB 530130

burster is ISO 9001:2015 certified

www.burster.com

Contents

1. For your safety	6
1.1. Symbols used in this manual.....	6
1.1.1. Signal words.....	6
1.1.2. Pictograms.....	6
1.2. General safety instructions.....	7
2. Introduction	8
2.1. Intended use.....	8
2.2. Customer service.....	8
2.2.1. Customer service department.....	8
2.2.2. Contact person.....	8
2.3. Environmental conditions.....	9
2.3.1. Storage conditions.....	9
2.3.2. Cleaning.....	9
2.4. Personnel.....	9
2.5. Scope of delivery.....	10
2.6. Unpacking.....	10
2.7. Warranty.....	10
2.8. Conversions and modifications.....	11
2.9. Definitions.....	12
3. Device design and general information	14
3.1. Mechanical design.....	14
3.2. Principle of operation.....	15
3.3. Static and quasi-static torques.....	15
3.4. Dynamic torques.....	15
3.4.1. Determination of the resonant frequency.....	16
3.5. Interference.....	16
4. Installation	17
4.1. Preparing for installation.....	17
4.2. Mechanical installation.....	18
4.2.1. Installation using mounting block.....	18
5. Torque sensor model 8656 with analog connection	19
5.1. Electrical connection.....	19
5.1.1. Power supply.....	19
5.1.2. Connector pin assignments (standard sensor, 1 range).....	19
5.1.3. The connections in detail.....	20
5.1.4. Running cables.....	22
5.1.5. Extension cables.....	22
5.2. Measurement.....	23
5.2.1. Switching on.....	23
5.2.2. Speed limits.....	23
5.2.3. Check function.....	23

Torque Sensor Model 8656

6. USB version of the torque sensor model 8656	24
7. Options	24
7.1. Angle / speed measurement.....	24
7.1.1. General information	24
7.1.2. Details	24
8. Calibration and adjustment	25
8.1. Factory calibration	25
8.2. Calibration certificate with accreditation symbol.....	25
8.3. Recalibration.....	25
9. Taking out of use	26
10. Technical data	27
10.1. Electromagnetic compatibility	27
11. Accessories available	27
12. Disposal	28



1. For your safety

The following symbols on the torque sensor model 8656 and in this operation manual warn of hazards.

1.1. Symbols used in this manual

1.1.1. Signal words



The following signal words are used in the operation manual according to the specified hazard classification.

	DANGER
High degree of risk: indicates a hazardous situation which, if not avoided, will result in death or serious injury	
	WARNING
Moderate degree of risk: indicates a hazardous situation which, if not avoided, may result in death or serious injury.	
	CAUTION
Low degree of risk: indicates a hazardous situation which, if not avoided, could result in minor or moderate injury.	
NOTICE	
Property damage to the equipment or the surroundings will result if the hazard is not avoided.	

Note: It is important to heed these safety notices in order to ensure you handle the torque sensor model 8656 correctly.



IMPORTANT: . Follow the information given in the operation manual.

1.1.2. Pictograms

	Electric shock hazard.
	Observe the advice for protecting the torque sensor model 8656.

1.2. General safety instructions

The torque sensor model 8656 uses state-of-the-art engineering and is safe to operate. However, if the torque sensor model 8656 is not used or operated as intended, it may present a hazard.

	 DANGER
	<p>Danger of electric shock! The following instructions must be followed to prevent electric shock and injuries:</p> <ul style="list-style-type: none">• In order to achieve high measuring characteristic value, the torque sensor model 8656 is not designed with the usual safety factors (2...20) for machine designs. For applicable overload factors, see the technical data (data sheet).• Observe accident prevention regulations, including for accessories used.• Use torque sensor model 8656 only in non-safety-critical applications.• Only use torque sensor model 8656 outside of potentially explosive areas (Ex protected areas).

NOTICE

The following points must be observed to prevent injuries and damage to property:

- The limits for permissible mechanical, thermal and electrical loads are shown in the data sheet. These limits must not be exceeded. Take these limits into account when planning the measuring arrangement, and during installation (preferably with the display for the torque connected) and operation.
- Impacts and shocks may damage the torque sensor model 8656 (e.g. if it is dropped). Exercise the necessary care when transporting and fitting the torque sensor model 8656.
- Torque peaks in excess of the permissible overload may destroy the torsion shaft. Make sure that such peaks do not occur, or ensure that they are absorbed.

2. Introduction

IMPORTANT: Read the operation manual carefully before using the equipment, and keep for future reference Bestimmungsgemäßer Gebrauch

2.1. Intended use

The torque sensor model 8656 measures static and dynamic torques on rotating or stationary machine parts in either direction of rotation. You have the option of measuring rotational speed or angular displacement. The respective upper range value is shown on the type plate. For the dual-range sensor, the larger full-scale value is given. The USB version of the 8656 torque sensor model 8661 transmits all measurement signals via USB.

Both the low mass of the torque sensor model 8656 and its high torsional rigidity are an advantage when measuring dynamic torques. However, you need to pay attention to the torsion spring constant and the sensor's cut-off frequency with such measurements. You can find both of these in the data sheet. For more information on estimating the resonant frequency and measuring dynamic torques see chapter 3.4 „Dynamic torques“ on page 15.

The torque sensor model 8656 is maintenance-free thanks to its contactless transmission of the measurement signal. The electrical measurement signals can be transmitted to remote measuring stations where they can be displayed, recorded, processed and used for control and regulation tasks.

Use the torque sensor model 8656 only for measuring torque and rotational speed or angular displacement

Do not use the torque sensor model 8656 in safety-critical applications.

The torque sensor model 8656 is not intended for use as a safety device

2.2. Customer service

2.2.1. Customer service department

For repair inquiries, please telephone our Service department on +49-7224-645-53.

Please have the serial number to hand. The serial number is essential to establishing the definite technical status of the torque sensor model 8656 and providing help quickly. You will find the serial number on the type plate of the torque sensor model 8656.

2.2.2. Contact person

If you have any questions relating to the torque sensor model 8656, please contact your representative or go directly to burster präzisionsmesstechnik gmbh & co. kg.

Headquarters

burster präzisionsmesstechnik gmbh & co kg
Talstraße 1 - 5
76593 Gernsbach
Germany

Tel: (+49) 07224 645-0
Fax: (+49) 07224 645-88
E-Mail: info@burster.com

Torque Sensor Model 8656

2.3. Environmental conditions



- Avoid radiant heat or cooling from one side.
- Protect the torque sensor model 8656 from moisture.
- The torque sensor model 8656 is **not** resistant to the effects of chemicals. **Do not** use the torque sensor model 8656 in a corrosive environment.
- Keep the bearings and connectors free of dust, dirt and other foreign matter.

2.3.1. Storage conditions

Use clean packaging to package the torque sensor model 8656. The torque sensor model 8656 must be stored under the following conditions:

- Dry atmosphere
- No condensation
- Temperature between +0 °C and +60 °C

2.3.2. Cleaning

	 DANGER
	Electric shock hazard! Disconnect the torque sensor model 8656 from the electrical supply before cleaning

Disconnect the torque sensor model 8656 from the power supply and use a dry cloth to clean it

	CAUTION
	Do not immerse the torque sensor model 8661 in water or hold it under running water. Do not use strong cleaning agents as these may damage the torque sensor model 8661. Use a dry cloth to clean the device.



2.4. Personnel

Personnel must be familiar with the relevant regulations. They must follow these regulations. Only trained personnel who are familiar with the applicable safety regulations are permitted to operate the torque sensor model 8656.

2.5. Scope of delivery

- Torque sensor model 8661
- Mating connector
- Operation manual
- Data sheet
- Optional: USB cable

2.6. Unpacking

	 DANGER
	<p>Electric shock hazard! Never connect up the torque sensor model 8656 if it shows signs of damage incurred in transit. Only ever use the torque sensor model 8656 under the conditions specified in this operation manual.</p>

Inspect the torque sensor model 8656 carefully for damage. If you suspect that the torque sensor model 8661 has been damaged during shipping, notify the delivery company within 72 hours.

The packaging should be retained for examination by a representative of the manufacturer and/or the delivery company.

The torque sensor model 8656 must be shipped only in its original packaging or in packaging capable of providing an equivalent degree of protection. The torque sensor model 8656 must be held securely (immovable) in its packaging.

2.7. Warranty

burster praezisionsmesstechnik gmbh & co kg provides a manufacturer's warranty for a period of 24 months after delivery.

Any repairs required during this time will be made without charge. This does not include damage arising from improper use.

Please note the following when sending the torque sensor model 8656 in for repair:

- If there is a problem with the torque sensor model 8656, please attach a note to the sensor case summarizing the fault.
- Technical specifications subject to change at any time without notice. We also state explicitly that we do not accept liability for consequential damage.
- The torque sensor model 8656 must always be dispatched in suitable packaging.

2.8. Conversions and modifications

Note: If you open or dismantle the torque sensor model 8656 during the warranty period, this will void the warranty **immediately**.

The torque sensor model 8656 does not contain any parts that are intended to be serviced by the user. Only the manufacturer's own qualified personnel are permitted to open the torque sensor model 8656.

It is forbidden to make any modification to the torque sensor model 8656 without our written permission. We cannot accept liability in the event of such action.

Our recommendations

- Check the bearings at least once a year to see that they still move freely.
- Replace the special low-friction bearings after a maximum of 20.000 hours of operation. In continuous operation at high speeds it may be necessary to replace the bearings sooner.
- Check cables and connectors annually.
- It is up to you as the user to determine the recalibration interval. We recommend that you check/recalibrate the torque sensor model 8661 after no longer than 12 months. Further details are given in chapter 8 „Calibration and adjustment“ on page 25.

2.9. Definitions

Test side

The test side is that end of the shaft at which you apply the torque being measured to the torque sensor model 8656.

This side normally has the smallest moment of inertia.

You will see these markings on the measurement end of the torque sensor model 8656:

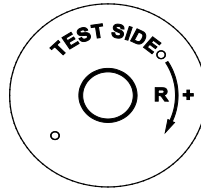

Diagram 1 Test side torque sensor model 8656

Drive side

The drive side is the opposite end to the measurement end. The torque sensor model 8656 is also mechanically connected at this side.

This side normally has the larger moment of inertia.

You will see these markings on the drive side of the torque sensor model 8656:

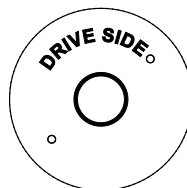

Diagram 2 Drive side torque sensor model 8656

The torque direction

A torque is clockwise (clockwise torque) if the torque is exerted clockwise when looking at the measurement end. In this case you will get a positive electrical signal at the torque sensor model 8656 output.

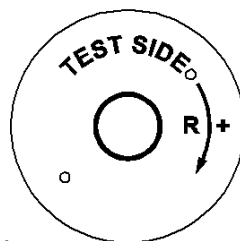

Diagram 3 Torque, clockwise (looking at the test side)

You can use the torque sensor model 8656 to measure both clockwise and counterclockwise torques. If the torque is exerted in an anticlockwise direction (looking at the measurement end), you will get a negative signal at the output.

Sign convention for measuring angular displacement

If the sensor shaft rotates clockwise (looking at the drive end), channel A leads channel B by 90°.

If the sensor shaft rotates anticlockwise (looking at the drive end), channel B leads channel A by 90°.

Static and quasi-static torques

Static and quasi-static torques change their value only slowly or not at all. As long as they are below the rated torque, these torques can take any value.

Dynamic torques

A dynamic torque changes very rapidly and can even oscillate. In this case the frequency of the torque must remain well below the resonant frequency of the mechanical structure as a whole.

We recommend that you only measure dynamic torques, if they reach a maximum 70% of the rated torque. The characteristics of your signal analysis and control systems must be taken into account during dynamic testing. When measuring dynamic torques, take the characteristics of your measuring amplifier into account.

For more information on estimating the resonant frequency and measuring dynamic torques, see chapter 3.4 „Dynamic torques“ on page 15.

3. Device design and general information

Specifications as full dimensions, mass and power depend on the version of the torque sensor model 8656. Please refer to the data sheet for specifications.

3.1. Mechanical design

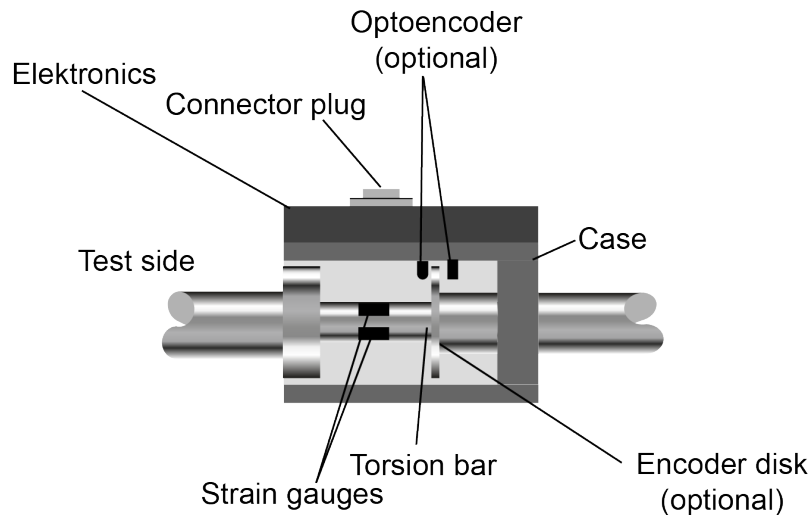

Diagram 4 Design principle torque sensor 8656

The torque sensor model 8656 essentially consists of three elements:

- Measuring shaft
- Electronic box
- Case

The measuring shaft is composed of torsion bar, strain gauges, instrumentation amplifier and power and signal transmission components. If the torque sensor model 8656 is fitted with the rotational speed or angular displacement option, an incremental encoder disk is also fitted for measuring rotational speed or angular displacement (see chapter 7.1 „Angle / speed measurement“ on page 24).

The electronics housing contains the stator electronics. The housing holds the rotor and two ball bearings.

3.2. Principle of operation

Torque deforms the torsion shaft and, as it does so, also elastically and reversibly elongates the strain gauges mounted on the shaft. The electrical resistance of these strain gauges changes proportionally to their elongation.

The torque sensor model 8656 has a total of four strain gauges. These are arranged as a Wheatstone bridge circuit and are supplied with a DC voltage by the electronics. The output voltage from the strain gauges changes in direct proportion to the measured torque. This voltage is amplified before being digitized by an analog/digital converter.

A 16-bit microprocessor processes these digital signals, encodes them and relays them to infrared LEDs, which send the signals to the stator as a serial light signal.

The stator receives this light signal and converts it back into electrical pulses before sending it to another microprocessor. This microprocessor controls a digital/analog converter which generates an analog voltage again (16-bit resolution). This analog voltage is the sensor's measurement signal. It is also proportional to the measured torque.

3.3. Static and quasi-static torques

Static and quasi-static torques change their value only slowly or not at all. As long as they are below the rated torque, these torques can take any value.

3.4. Dynamic torques

	NOTICE
	Resonance hazard! Operating the torque sensor model 8656 or the entire test setup close to its resonant frequency will result in permanent damage. Keep the torque frequency well below the resonant frequency of the mechanical test setup. Limit the peak-to-peak torque variation to 70 % of the rated torque..

Note: A calibration carried out for static torques is also valid for measuring dynamic torques.

3.4.1. Determination of the resonant frequency

The resonant frequency of the entire test setup is related to the sensor's spring constant "c" and to the two moments of inertia "J1" and "J2", each with the connected molding body.

$$f_0 = \frac{1}{2 \cdot \pi} \cdot \sqrt{c \left(\frac{1}{J_1} + \frac{1}{J_2} \right)}$$

f₀: Resonant frequency in Hz

J₁: Moment of inertia 1 in kg · m²

J₂: Moment of inertia 2 in kg · m²

c: Spring constant in Nm / rad

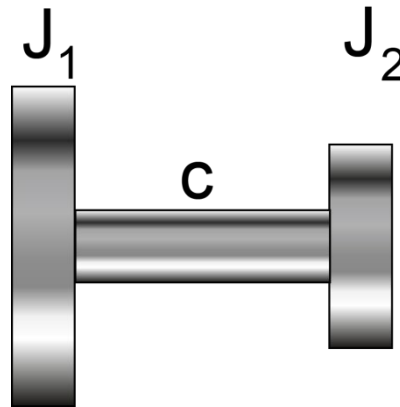

Diagram 5 Resonant frequency model

The Holzer-Tolle method is another way to determine the resonant frequency.

3.5. Interference

Possible sources of interference:

- Temperature change
- Temperature gradient
- Vibration
- Spurious force
- EMC
- Electrical interference
- Magnetic interference
- Angular, axial or radial misalignment (also see chapter 4.1 „Preparing for installation“ on page 17).

IMPORTANT: Take suitable measures to counter these sources of interference because otherwise they may cause an incorrect measurement result.

4. Installation

4.1. Preparing for installation

Shafts

We recommend an H7/j6 shaft fit to ensure correct assembly and good torque transfer.

Mounting surfaces

The mounting surfaces for the torque sensor model 8656 or for the optional mounting block must be free of lubricants, particles or burrs.

Couplings and misalignments

Even if you align the torque sensor model 8656 precisely, there will always be a minimum misalignment between the shafts. Therefore, when fitting the torque sensor model 8656, always use balanced couplings that allow misalignment correction.

IMPORTANT: Before fitting the coupling, check its maximum rated speed.

Different kinds of missalignments

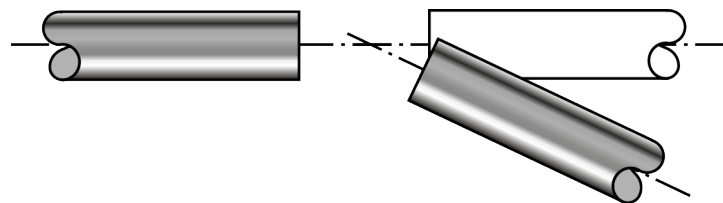

Diagram 6 Angular misalignment

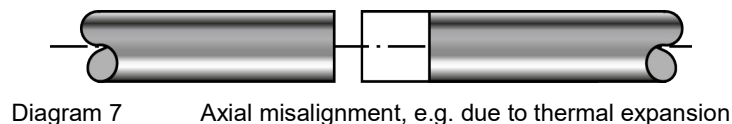

Diagram 7 Axial misalignment, e.g. due to thermal expansion

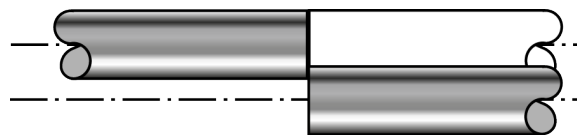



Diagram 8 Radial misalignment

Couplings should be used for easy mounting and integration into your equipment; further information in Data Sheet 8690 (<https://bit.ly/3rVK6cC>).

4.2. Mechanical installation

4.2.1. Installation using mounting block

	NOTICE
	<p>Avoid excessive torques, bending moments or axial forces! Excessive torques, bending moments or axial forces may damage the torque sensor model 8656. Connect the electrical cable to the torque sensor model 8656 during fitting and monitor the measurement signal. This signal must remain within the permitted range. Support the torque sensor model 8656 during fitting to make sure it does not drop, and do not resort to hammering to aid installation.</p>

We recommend fitting the torque sensor model 8656 with an associated mounting block, model number 8600-Z2X. Mounting blocks have the advantage of an extra locating pin to help align the torque sensor model 8656 easily. If the torque sensor model 8656 needs to be removed temporarily from the setup, the mounting block avoids any time-consuming realignment when it is refitted.

Couplings should be used for easy mounting and integration into your equipment; further information in Data Sheet 8690 ().

Mounting instructions



This is how it works

1. Clean and de-burr the shafts and hubs and any other contact and mounting surfaces on your components. At time of fitting, there must be no foreign matter, burrs or lubricants on these components.
2. Fit the torque sensor model 8656 on the mounting block. Use the locating pin to centre the torque sensor model 8656 on the mounting block then screw-fasten the sensor to the block.
3. First roughly align the mounting block. Initially only loosely tighten the assembly bolts on the mounting block.
4. Fit the full couplings on the shaft ends of the torque sensor model 8656. Always use the entire clamping length of these couplings. If possible, fit the torque sensor model 8656 starting from the test side. Initially only loosely tighten the fixing screws on the couplings.
5. Now align the mounting block precisely. This avoids any unnecessarily high reaction forces, while also reducing the load on the coupling and any spurious forces acting on the torque sensor model 8656. At low rotational speeds (< 2000 min⁻¹), it is usually sufficient to align the coupling using a straight edge in two perpendicular planes. However, we recommend using a dial gauge or laser to align the coupling and shaft ends.
6. Once you have fitted all shafts into the coupling hubs and correctly aligned all parts, tighten the fixing bolts on the mounting block.

IMPORTANT: Make sure you do not move the mounting block when tightening.

7. Tighten each coupling to hold the shaft firmly, making sure you observe the following requirements:

- a. Start on the side that is easier to turn. Usually this will be the measurement side.
- b. Do not exceed the permitted torques. Use a torque wrench.
- c. Hold screws from the other end when tightening.
- d. Be aware of the maximum forces that you apply. The resultant torques must lie below the rated torque of the torque sensor model 8656. The relevant values are listed in the data sheet.

5. Torque sensor model 8656 with analog connection

5.1. Electrical connection

5.1.1. Power supply

The operating voltage is supplied to the standard model of the torque sensor model 8661 via the connecting plug

5.1.2. Connector pin assignments (standard sensor, 1 range)

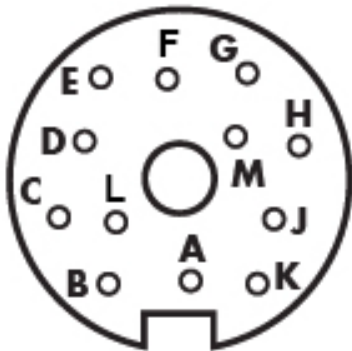

Pin:	Funktion Function:
C	Momentausgang Torque, voltage output
D	Momentausgang (Masse) Torque, output ground
F	Speisespannung Sensor supply, voltage
E	Speisespannung (Masse) Sensor supply, ground
K	Kalibriersignalansteuerung Control input
L	Nicht belegt not connected
B	Winkelausgang B Angular displacement Ch. B
J	Masse für Kal, $M_{\text{rot}} \angle$ GND für Kal, $M_{\text{rot}} \angle$
G	Winkelausgang A (Drehzahlausgang) Angular displacement CH. A (Rotary speed, output)
A, H, M	Nicht belegt not connected
Gehäuse case	Abschirmung Shield

5.1.3. The connections in detail

Voltage output for torque

This consists of an operational amplifier with a downstream low pass filter.

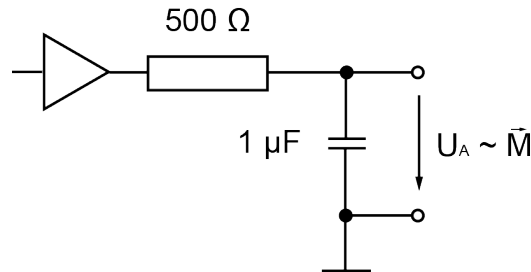

Diagram 9: Voltage output for torque

The connected evaluation circuit should be high impedance ($> 10 \text{ M}\Omega$). The reference is the potential separated torque output ground. You can connect this to the supply ground on the evaluation device.

TTL output for rotational speed / angular displacement

Both channels are designed the same way. A TTL signal is available directly, without additional external circuitry. The reference here is the supply ground. You can connect this to the torque output ground on the evaluation device.

Note: In conjunction with the internal pull-up resistor, the cable capacitances form a low-pass filter. You should therefore use the shortest possible, high quality, low capacitance cable for maximum transmission quality.

Here the external voltage is superimposed on the internal voltage source. As a result, for example, you can connect the torque sensor model 8656 directly to a PLC input with positive logic (not for American PLCs). Using the same connection method you can reduce problems with transmission quality with longer cables.

Guide value $12 \text{ V} / 1 \text{ k}\Omega$ (0,5 W).

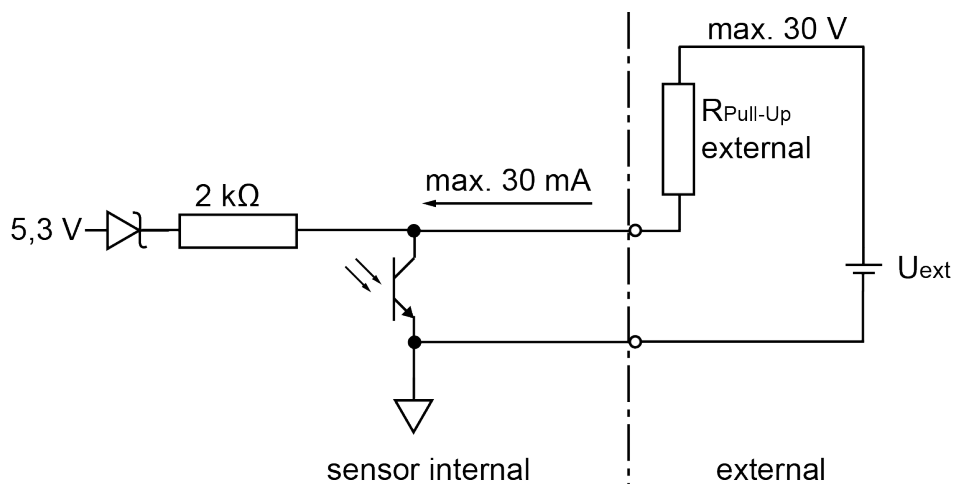

Diagram 10: Open collector output

TTL output on 3.3 V or other logic

The diagram shows adaptation for 3.3 V logic. For other logic levels, appropriate Zener diodes need to be used.

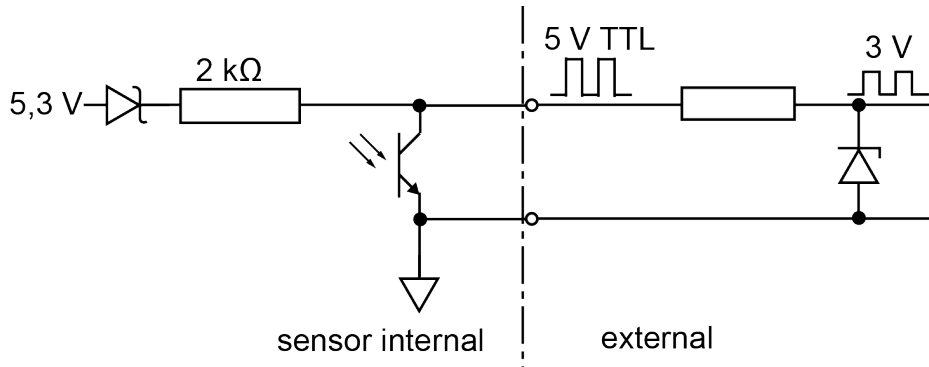

Diagram 11: Resistance 10 kΩ, Zener diode 3.3 V

Longer transmission paths up to approx. 10 m

CAUTION

!

Danger of excessive heating!
 When connected to a voltage source, the torque sensor model 8656 overheats. This overheating will permanently damage the torque sensor model 8656.
Always use a pull-up resistor in the voltage source connection..

Depending on the cable type, cable cross-section, cable length and frequency, you may need to select a somewhat smaller pull-up resistor.

Pay attention to the maximum current and voltage values, and to the fact that considerable power is dissipated at the pull-up resistor and Zener diode.

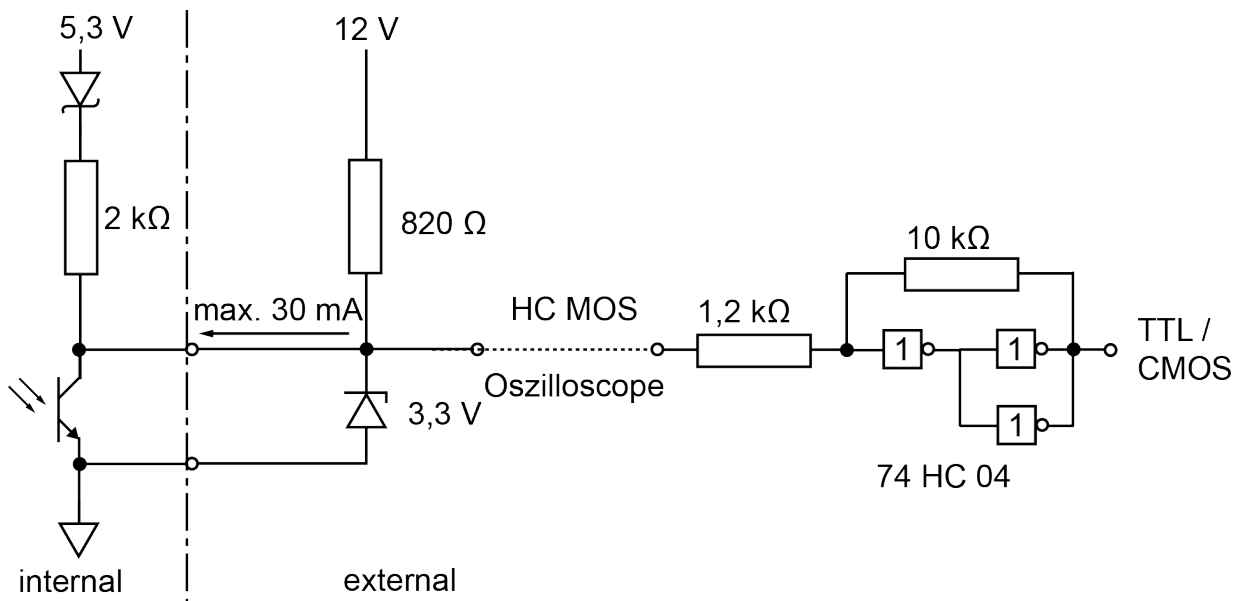

Diagram 12: Longer transmission paths

5.1.4. Running cables

Electrical and magnetic fields can often be picked up by the test leads, causing interference. Such interference mainly stems from power cables running parallel to the test leads, but can also be caused by contactors, thyristor controllers, variable frequency drives and electric motors in the vicinity. Ensure these are a sufficient distance away and route test leads through a grounded steel pipe if necessary.

Galvanic interference can also occur, particularly if the measurement chain is grounded at multiple points creating differences in electrical potential. These ground loop currents can be avoided by either disconnecting the double grounding or bypassing it by running a particularly low-resistance ground cable (6-10 mm²) parallel to the test lead.

Grundsätzlich gilt:

- The torque sensor model 8661 must be grounded via its assembly bolts.
- Run the cable loosely and with enough play in the cable to allow for any movement.
- Avoid any tension on the connecting plug.
- Avoid excessive lengths. If that is not possible, snake the cable. This will reduce the effective induction area.

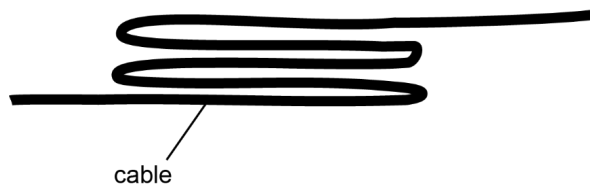

Diagram 13: Layout of a cable with excess length

- Locate the torque sensor model 8661, cable and measuring instrument outside the field of high-energy equipment. These include transformers, motors, contactors, frequency converters and so forth. Otherwise the electromagnetic fields from such equipment will act with their full effect on the measuring chain, causing incorrect measurements.
- Lay the measuring lines separately from high-power cables. If the measuring lines are laid parallel to such cables, interference will be coupled in inductively and capacitively.

Note: In some cases it is helpful to pull an extra shield as additional protection over the measuring cable, or to lay the cable in a metal tube or pipe, which must be grounded.

5.1.5. Extension cables

- Always use shielded, low-capacitance cables.
- We recommend using cables supplied by burster präzisionsmesstechnik gmbh & co. kg. These cables meet the requirements.
- For extension cables, make sure that the connection is flawless with good insulation.
- Make sure that cable cross-section is sufficient.

Note: If you use extension cables it is not necessary to recalibrate the torque sensor model 8656. However, you will need to adjust the entire measuring chain.

IMPORTANT: If a burster cable of type 99540-000F-05200XX is ordered with the sensor, a ceramic capacitor is supplied with the cable. This ceramic capacitor is needed only with torque sensors that include the angle/speed measurement option. The effect of the ceramic capacitor is to suppress potential cross-talk from the angular displacement/rotational speed output to the torque output. Connect the ceramic capacitor between the torque output and torque GND.

Torque Sensor Model 8656

5.2. Measurement

5.2.1. Switching on



This is how it works

1. Apply the operating voltage to the torque sensor model 8656.
2. The torque sensor model 8656 goes through a self-test mode lasting 4 seconds after power-up. After the self-test has been completed, the sensor is ready for operation.

5.2.2. Speed limits

	<h2>NOTICE</h2>
	<p>Excessive speeds will damage the torque sensor model 8656! Excessive forces arise above the maximum speed. Always operate the torque sensor model 8656 below the maximum speed (see data sheet).</p>

5.2.3. Check function

When a voltage U_b is applied to the test input, the torque sensor model 8656 outputs a signal of exactly 10.000 V at the analog output.

6. USB version of the torque sensor model 8656

For the USB version and DigiVision operation, see the DigiVision Torque Sensors Instruction Manual.

7. Options

7.1. Angle / speed measurement

7.1.1. General information

The torque sensor model 8656 can be equipped with integral angle/speed measurement. Chapter 7.1.2 „Details“ on page 24 contains technical details for analysing the speed/angle signals.

An encoder disk with 400 increments is available for integrated angle of rotation / speed measurement; it provides a max. angular resolution of 0.225°.

7.1.2. Details

An opto encoder scans a rotating encoder disk. This incremental encoder disk is made from a transparent material with opaque lines on it. This design is basically a high-resolution and fast light barrier. In operation, it generates a certain number of electrical pulses with each rotation. The frequency of these pulses is therefore dependent on the rotational speed of the shaft and the number of lines on the encoder disk.

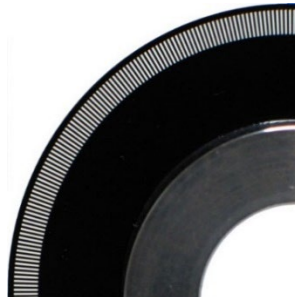

Diagram 14: Close-up view of the encoder disk

If the torque sensor model 8656 includes the speed/angle option, the speed/angle output supplies a 5 V TTL signal. However, you can also use this output as an open collector output. For the USB version of the torque sensor model 8656, the measurement data for the torque and also for speed and angle is transmitted digitally via USB.

The principle of measuring angular displacement is the same as for measuring rotational speed. However, in this case the sensor reads two channels. The electrical pulses from the two channels A and B are offset by 90°, which also allows the shaft's direction of rotation to be identified.

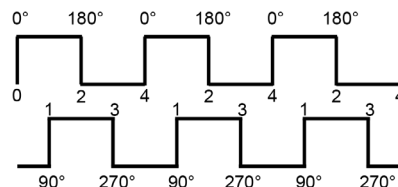

Diagram 15: Angular displacement measurement, channel offset 90°

To detect the angle, you need to evaluate the rising and falling pulse edges for both channels (four-edge decoding). Hence the angular resolution is four times the number of lines on the encoder disk. An encoder disk with 400 lines therefore gives a resolution of $360^\circ / (4 \times 400) = 0,225^\circ$.

For more information on the sign convention, see chapter 2.9 „Definitions“ on page 12 **Fehler! Textmarke nicht definiert.**

8. Calibration and adjustment

The torque sensors model 8656 from burster praezisionsmesstechnik gmbh & co. kg are already traceably adjusted and tested in the factory. As an option we offer factory calibration of the torque sensor model 8656.

8.1. Factory calibration

As part of the traceable burster factory calibration, the torque sensor model 8656 is checked for calibratability, and is then calibrated and provided with a calibration label and a calibration certificate. The burster factory calibration certificate includes the following information as a minimum:

- Measurement values and measurement uncertainty.
- Reference standards used including measurement uncertainty and traceability
- Zero offset, output sensitivity and interpolation error.
- Peak-to-peak range, hysteresis voltage and toggle (relative zero offset right-left).

8.2. Calibration certificate with accreditation symbol

An accredited calibration involves calibrating the torque sensor model 8656 in a calibration laboratory accredited according to ISO 17025 (DAkkS). The calibration is carried out according to DIN 51309 with 8 torque steps.

It is essentially the user's responsibility to set suitable recalibration dates. In the case of an accredited calibration, the user should note that based on current standards, the validity of the DAkkS calibration lasts for no longer than 26 months.

8.3. Recalibration

Quality management standards require regular calibration of any measurement and test equipment that you use in quality-related processes. The reason for this is to ensure measurements are always made correctly, thereby keeping the risk of measurement errors in check.

We recommend that all measurement and test equipment is inspected every 12 months. We advise an immediate inspection if any damage is suspected.

Shorter intervals are recommended in the following cases:

- Torque sensor model 8656 overload.
- After repair.
- After improper use of the torque sensor model 8656.
- When required by quality standards.
- Where there is a specific traceability requirement.

If you have any questions about the torque sensor model 8656 or calibration, please contact our Customer Service team by phone on +49-7224-645-53 or by email at service@burster.com.

9. Taking out of use

- Remove the torque sensor model 8656 correctly.
- Protect the torque sensor model 8656 from knocks.
- Protect the torque sensor model 8656 against bending moments.
- Support the torque sensor model 8656.
- Do not drop the torque sensor model 8656 **under any** circumstances.

10. Technical data

The data sheet for the torque sensor model 8656 contains the detailed technical specification. You can obtain the latest data sheet and additional information on the torque sensor model 8656 from <https://bit.ly/3xrLdSz> or simply use the QR code below:



Diagram 16 QR code for the torque sensor model 8656 product page

10.1. Electromagnetic compatibility

Interference immunity

Interference immunity to EN 61326-2-3:2006

Industrial locations

Emitted interference

Emitted interference to EN 61326-2-3:2006

11. Accessories available

The data sheet for the torque sensor model 8656 contains details of the accessories available. You can obtain the latest data sheet and additional information on the torque sensor model 8656 from <https://bit.ly/3xrLdSz> or simply use the QR code below:



Diagram 17 QR code for the torque sensor model 8656 product page

12. Disposal



Battery disposal

As an end user, you are required by law (battery ordinance) to return all used batteries and rechargeable batteries; the disposal through household waste is prohibited. By buying the herein described device you are concerned by this law. Please dispose of your batteries and rechargeable batteries correctly. Hand them to waste disposal sites either at your premises or at our company or at any place where batteries/rechargeable batteries are sold.

Equipment disposal

Please fulfill your legal obligations and dispose of unserviceable equipment in accordance with applicable legal requirements. Thus you contribute to environmental protection.