



**ESCOM**  
Enhanced Solutions

# VaRoM

Valve Rotation Monitoring

VaRoM IS A **UNIQUE** PATENTED INVENTION, FIRST IN THE WORLD THAT CAN MONITOR THE **VALVE ROTATION** CONDITIONS OF **INTERNAL COMBUSTION** ENGINES USED IN MANY **POWER PLANTS** AND **MARINE** INDUSTRY.

**VaRoM** will minimize the risks of VALVE FAILURE or SEIZURE by enabling 7/24 monitoring of valve rotation and temperature, and transmits the collected data via wireless communication protocols to Main Engine Control Interface. Operators can monitor and follow each valve's real time data on SCADA, and long term information with engine conditions at once. Combining these information with the clear and colorful images you will gain a fuller picture of engine valve's condition through VaRoM.

**VaRoM** will monitor the rotation speeds, and temperature of the valves in a continuous, reliable and safe manner. In this way, it is to minimize the possibility of malfunction with a preventive, predictive and superior technological approach to the valve failure problem, which causes large work and production loss, very high repair, spare parts and labor costs, which are frequently seen in diesel engines. Via ESCOM Enhanced Solutions, we are able to go in depth in accessible knowledge.



## VaRoM

Valve Rotation Monitoring

**VAROM**, is the first solution to be installed on the inlet and exhaust valves of engines and provides vital data about the valve rotation and temperature. thus, operators can follow the valve conditions and apply preventive and protective maintenance against valve break failures which are very common failures in reciprocating engines and one single valve failure can cause millions to recover the engine.

#### PRODUCT HIGHLIGHTS

- Integrated Batteryless - Wireless sensor solution
- Plug And Play
- Energy harvesting by vibration
- Power Management circuit
- 7/24 monitoring the rotation and temperature of valves
- Predictive & Protective approach against to Valve Failure of reciprocating Engine

## ESCOM-ES SENSING PRODUCT

### VAROM – VALVE ROTATION MONITORING



**VaRoM**  
Valve Rotation Monitoring

## FEATURES AND BENEFITS

- Easy-to-use Scada application to visualize and analyze sensor data.
- Automatically collects BLE data sent from the sensor.
- Can store the data locally and visualize the data in HMI.
- Energy harvesting at low frequencies for reciprocating engines
- Available in a range of different resonance frequencies
- High power to weight ratio
- Highly efficient AC/DC and DC/DC Power Management System (PMS)
- MPPT (Maximum power point tracking) to extract energy as efficiently as possible in different vibration conditions
- Integrated sensors and wireless communication
- **Ultra**-low power 3 axis accelerometer
- **Ultra**-low power 3 axis gyroscope
- Temperature sensor
- BLE (Bluetooth Low Energy) communication
- Custom DC power analyzer which continuously measures the charge power generated from the harvester and transmits information via BLE



**VaRoM**  
Valve Rotation Monitoring

**Easy-to-use Scada** application to visualize and analyze sensor data. Automatically collects BLE data sent from the sensor. Can store the data locally and visualize the data in HMI.

No need to transfer power or data via wire. Data collected from batteryless Bluetooth Sensors Network (BSN) are transferred over WIFI or Low Power BLE Technology, converted, and transmitted to the Server via Sensor Hub Module within complete wireless scheme to integrate into your system with various industrial interface options.

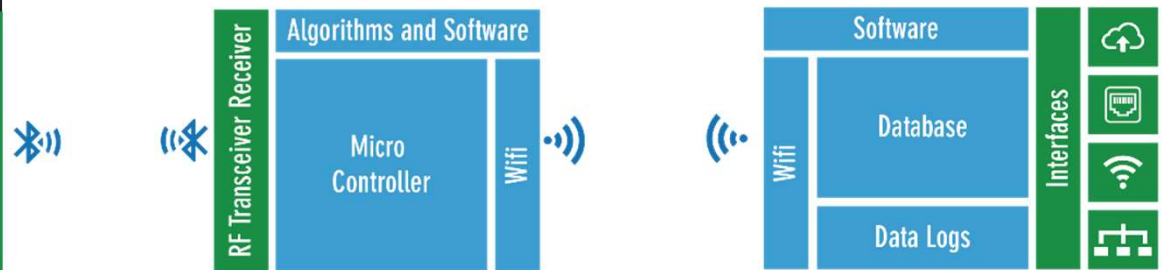
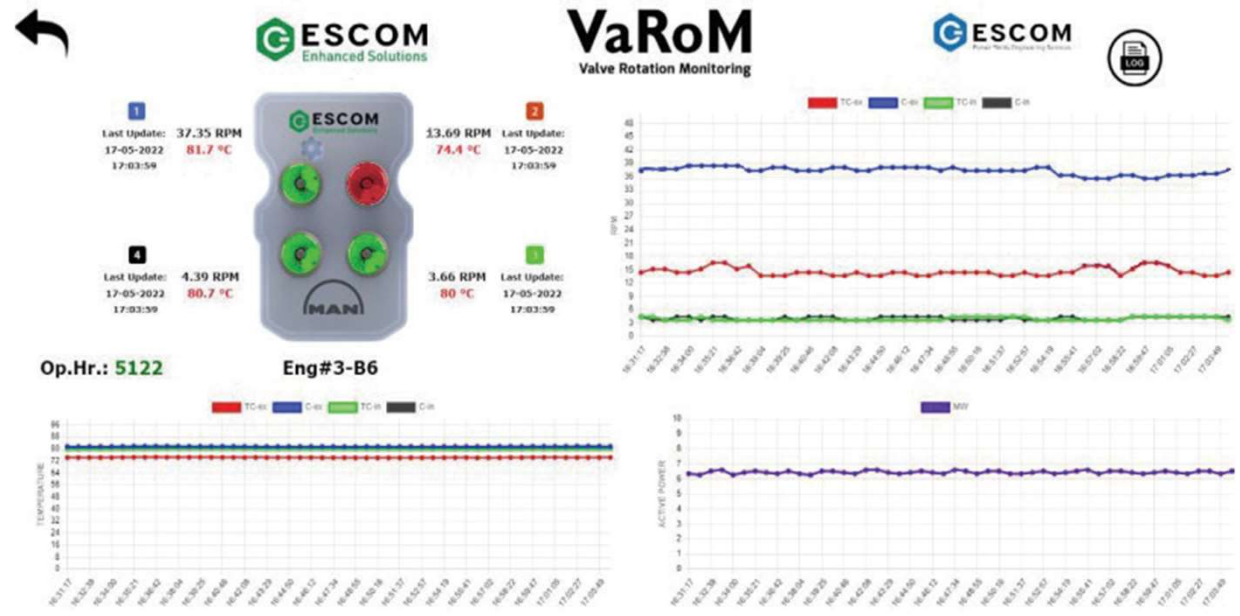
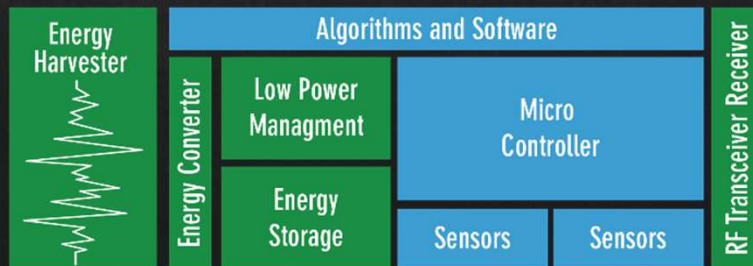

## 01 - What is VaRoM?

## 02 - What Does VaRoM Do?

## 03 - Why VaRoM ?

## 04 - What are the advantages of VaRoM?

## 05 - For Whom VaRoM Was Developed?

VaRoM is an innovative product, provides a vital data for Diesel/HFO Engines which has never been monitored before.

VaRoM measures

- Valve Rotation Speed,
- Valve Stroke (optional)
- Temperature of Exhaust - Inlet valves of engines which are the indication of easy valve movement.

Valve Seizure or Valve Break Failure is one of the catastrophic incidents that frequently happens in Diesel/HFO Engines due to bad combustion deposits and corrosion on valve stem and guides and result in very expensive property damages like cylinder head, piston, connecting rod, liner, and turbocharger. Rehabilitation and repair works will take too much time, effort and costs.

VaRoM will minimize this risk by enabling 7/24 monitoring of valve rotation and temperature. Conventional sensor technology cannot be used inside the engine, and on moving parts, due to harsh working environment. VaRoM is the first product introduces batteryless and wireless sensor solution and can be installed inside the engine. No cables or power source is needed, because VaRoM generates its own power by energy harvesting from vibration of the valves. And transmits the collected data via wireless communication protocols. Operators can monitor and follow each valve's real time data on SCADA, and in case of any indication of valve seizure, pre-alarm or shutdown alarms will save the engine components on time. VaRoM can be easily adopted and installed on various engine types and models.

- Innovative sensor technology
- No need to batteries or cables
- Continuous monitoring and control of valves
- Predictive and Preventive approach for valve break failure
- Easy to adopt and install on different engine models

Customizable, flexible, and scalable for customers' requirements

VaRoM is an innovative product, provides a vital data for Diesel/HFO Engines which has never been monitored before. VaRoM is developed for Diesel Engine Manufacturers, Power Plant Owners, Marine Shipowners, Power Ships, Operation and Maintenance Service providers.

**VaRoM**  
Valve Rotation Monitoring

Power Source : Vibration Harvester  
Power Consumption: <500 uWatt



**VaRoM**  
Valve Rotation Monitoring

Power Source : Vibration Harvester  
Power Consumption: <500 uWatt

Sensors:

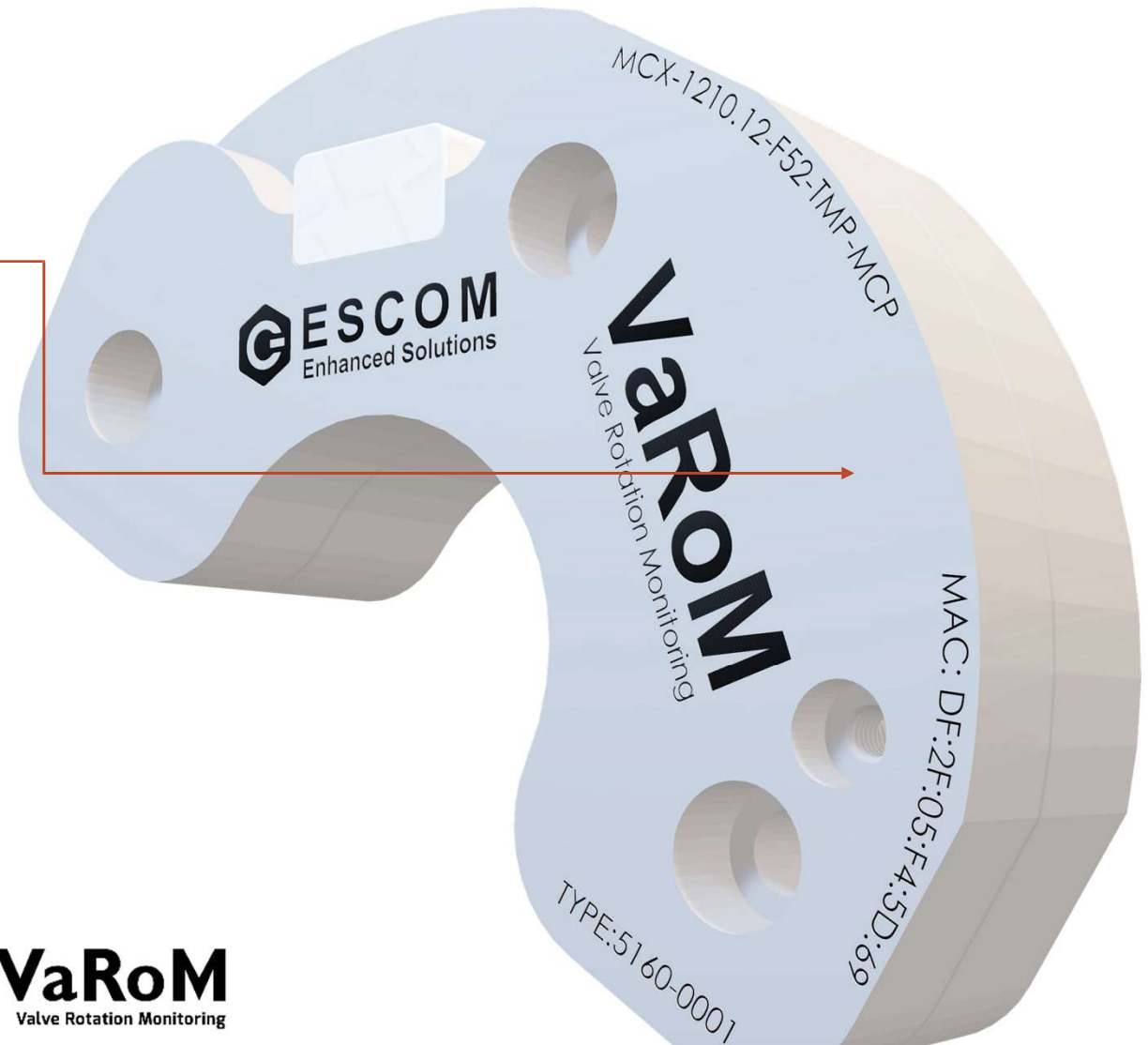

**VaRoM**  
Valve Rotation Monitoring



Power Source : Vibration Harvester  
Power Consumption: <500 uWatt

Sensors:  
Temperature,  
Accelerometer,  
Gyroscope



**VaRoM**  
Valve Rotation Monitoring

Power Source : Vibration Harvester  
Power Consumption: <500 uWatt

Sensors:  
Temperature,  
Accelerometer,  
Gyroscope

Easy installation with 3x M6 bolts

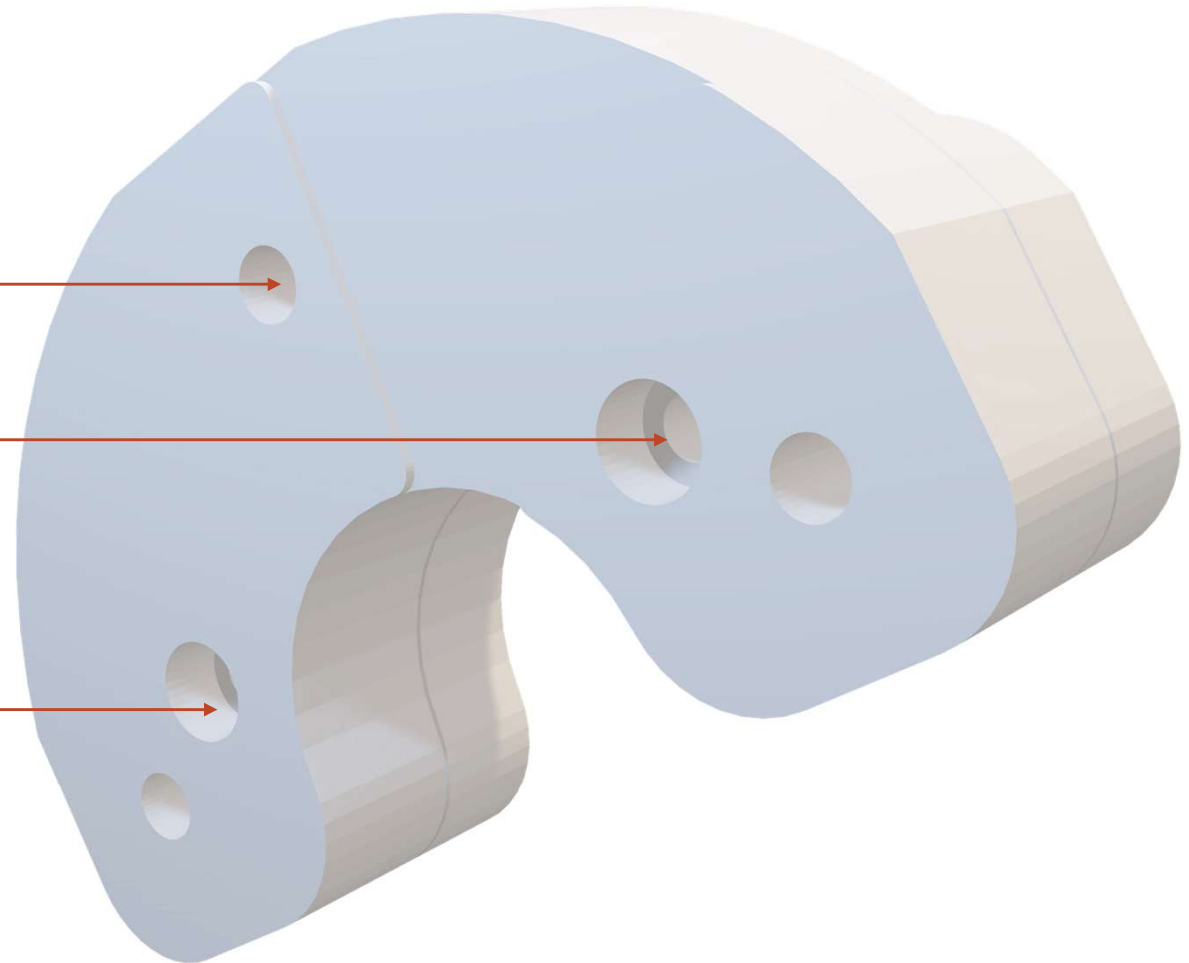

**VaRoM**  
Valve Rotation Monitoring

Power Source : Vibration Harvester  
Power Consumption: <500 uWatt

Sensors:  
Temperature,  
Accelerometer,  
Gyroscope

Easy installation with 3x M6 bolts

Data Transmission: WiFi – BLE  
Rf Transmission: +8dBm  
Sampling Rate: 40sec  
Process Rate: 1min



**VaRoM**  
Valve Rotation Monitoring

## TECHNICAL SPECIFICATIONS

**750 rpm MAN 32/40**
**500 rpm MAN 51/60**

Power Source (Self Powered )	Vibration Harvester	
Installed Sensors	Temperature, Accelerometer, Gyroscope	
Data Transmission	BLE	
Rf Transmission Power	+8dBm	
Sampling Refresh Rate	40s	
Proces Rate Complete	1 min.	
Data Output	Rpm, Temperature	
Weight	215 grams	320 grams
Dimensions	$\varnothing = 82\text{mm}$ $\varnothing = 25\text{mm}$ $h = 20.80\text{mm}$	$\varnothing = 108\text{mm}$ $\varnothing = 38\text{mm}$ $h = 28.70\text{mm}$
Operating Temperature	-40°C..... +105°C	
Power Consumtuion	<500 $\mu$ W	
Customizable	YES	

### 1- VaRoM INSTALLATION

To install the Valve Rotation Monitoring system on Valve Rotators, please follow the installation drawing “Mechanical Installation”.

### 2- SENSOR HUB INSTALLATION

Sensor Hub supports low range communication and can communicate with VaRoM on a special wireless network and transfers data to server via WiFi wireless protocol. Sensor hub shall be placed between 5 to 25 meters away from the cylinder head. 120-240V AC power socket is required.

### 3- WIFI ROUTER INSTALLATION

WiFi Router can be installed far away from the sensor sub considering 2.4G Wifi protocol and signal interferences.

WiFi Router is a gateway to remote access via internet and to server for acquisition from sensor hub.

LAN connection with internet access or 4G Modem connection is required.

### 4- SERVER INSTALLATION

Server can be placed anywhere with a LAN cable connection to router

## QUICK START GUIDE

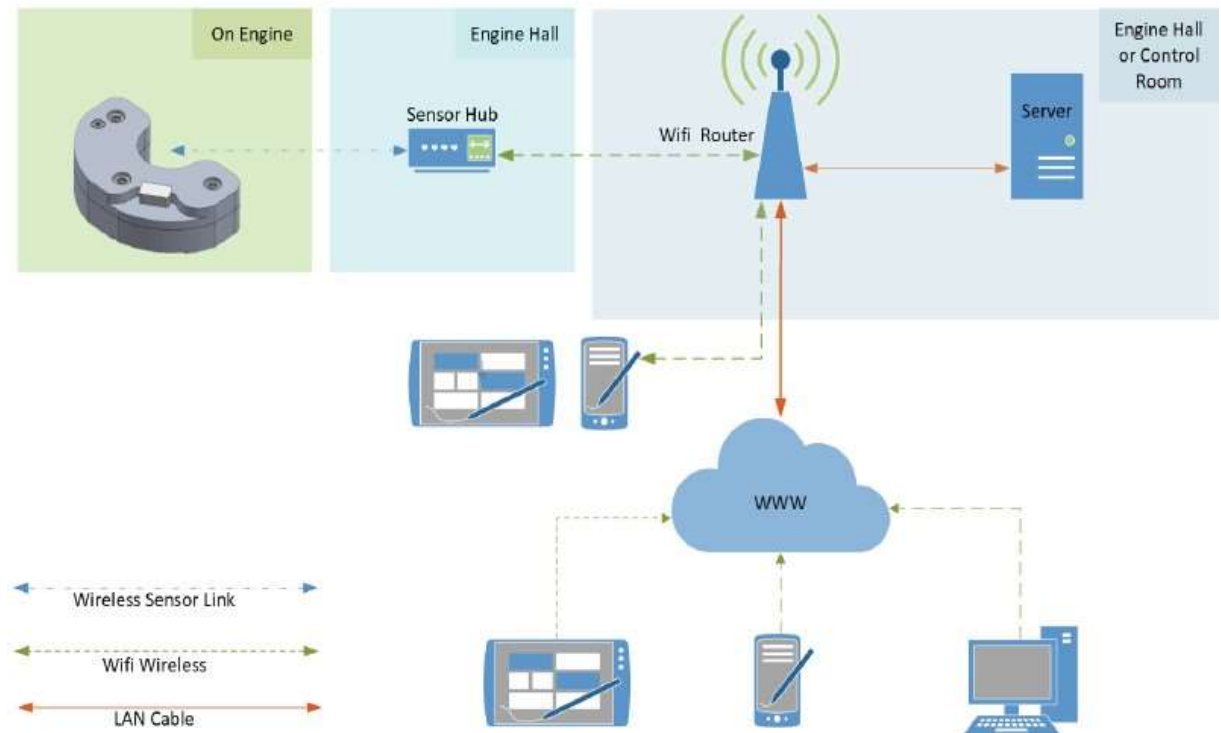

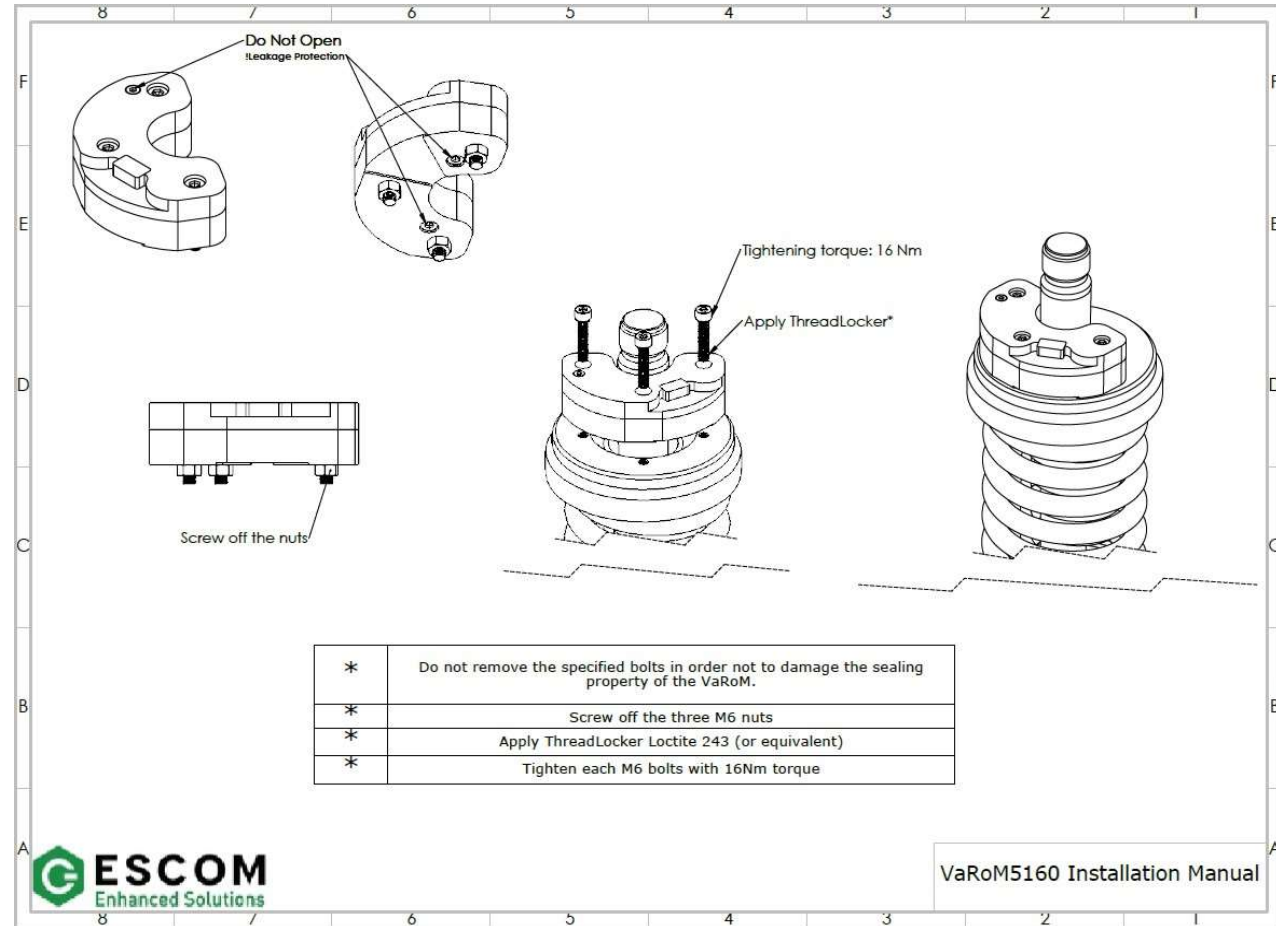

At a typical 750-rpm engine, each inlet/exhaust valve opens and closes 375 times a minute, each valve rotates app. 5/30 rev. per minute. and Inlet / Exhaust valves are designed to rotate, and this rotation is essential to valve longevity since it helps

- To prevent deposits from building up around the seat, stem, and guide
- To reduce the wear, the friction
- To increase the life period of the components.
- To maintain the conical valve face and seat clean of carbon or soot deposit that might appear on surfaces during valve opening. providing a good sealing of the cylinder
- To uniform the thermal stress of the valve head because of the asymmetry exhaust manifold
- To avoid another unwanted phenomenon Valve Burning.

## IMPORTANCE OF VALVE ROTATION

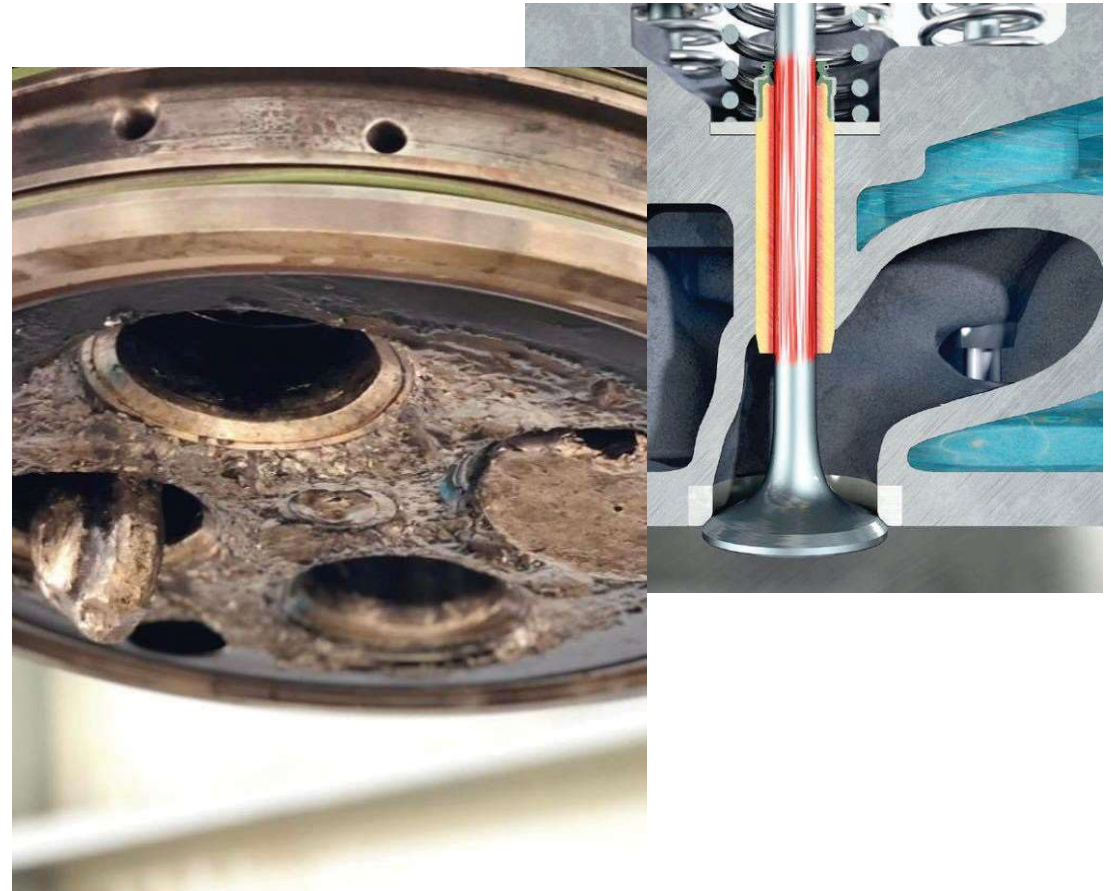

**VaRoM**  
Valve Rotation Monitoring

Another important result of the valve rotation is the uniformity of the oil film in the valve guide and on the valve stem. The wear caused by the contact between valve and rocker arm is reduced by varying the contact point

Precise alignment of the rocker arm is essential for proper valve rotation. A poorly aligned rocker arm can wear out a valve guide within 100 hours of engine operation and that wear can cause improper valve seating, hot spots, and valve damage or failure.

The different failure modes affecting the valve failures can cause costly and consequently vital equipment damage as piston, liner, turbocharger and crankshaft damages.



## IMPORTANCE OF VALVE ROTATION



**VaRoM**  
Valve Rotation Monitoring





## SITE TEST RESULTS

CUBA MAN 51/60DF

### CERTIFICATE OF SITE TEST COMPLETION

THIS IS TO CERTIFY THAT 8 PIECES OF

**VaRoM**  
Valve Rotation Monitoring

has been installed on 18V51/60 MAN Diesel Engine's exhaust valves on 4 different cylinders heads and tested successfully during 400 operating hours.

Name of Product	: VaRoM (Valve Rotation Monitoring)
Owner of Product	: ESCOM ENERJİ SANTRALLERİ MÜH. HİZM. LTD.ŞTİ.
Qty of tested device	: 8 pieces
Engine Type	: 18V51/60 (1 145 092) MAN Diesel Engine
Test Place	: Karpowership KPS62 - Cuba, Havana
Purpose of Test	: Continious Online Monitoring of valve rotation (rpm) and temperature
Duration of Test	: 400 hrs (10.09.2022 – 27.09.2022)

01.10/2022



**ESCOM**  
Enhanced Solutions



**KARPOWERSHIP**  
KPS62

**VaRoM**  
Valve Rotation Monitoring



**VISUALIZE ROTATION**

Visualize the rotation data of each inlet/exhaust valves of engine on different load and speeds. Compare with long term trends.

**QUICK ACTING**

Warn the operators or stop the engine immediately before any failure on valves.

**SENSE BEFORE FAILURE**

Track the valve condition and plan the maintenance according data from VaRoM.

**REDUCE COSTS**

Avoid failure and reduce big amount of standstill time, spare part and manpower costs.

**RELIABLE & SUSTAINABLE OPERATION**

Run in safe manner operation of engine.

**PLUG AND PLAY**

System is designed as plug and play. No additional infrastructure or installation required.

**SELF POWERED**

VaRoM harvests its own power from vibration on the valve, No battery or power cable required.

Compatible for different resonance frequencies.

**DATA OVER WIRELESS**

VaRoM transmits the processed data to HMI over wireless protocols.

**SENSOR FUSION**

VaRoM equipped with Ultra Low Power 3 axis accelerometer and gyroscope, temperature and optional sensors , so that combine all datas to valuable information with a Sensor Fusion Technology.

**7/24 MONITORING**

VaRoM has adaptable interfaces or own Scada application for operators to visualize.

**DATABASE**

All data from VaRoM can be stored in requested database options. Fully flexible on customizable options.

**TECHNICAL SUPPORT**

ESCOM Enhanced solutions supports customers 7/24 on every point.

**TURNKEY SOLUTIONS**

ESCOM-ES offers turnkey solutions for your brand new or existing engines.

For more information on any of our products or services please visit us on the Web at: [www.escom-es.com](http://www.escom-es.com)

**VaRoM**  
Valve Rotation Monitoring

## Sense Freely...

Self-Powered, Wireless, Batteryless

NOW POSSIBLE.

ESCOM-ES innovative technology achievements makes the wireless and battery free sensors possible to be used instead of conventional sensors, and contributing the cost effective and environment friendly sustainable solutions

## ENERGY HARVESTING for the FREEDOM of SENSORS

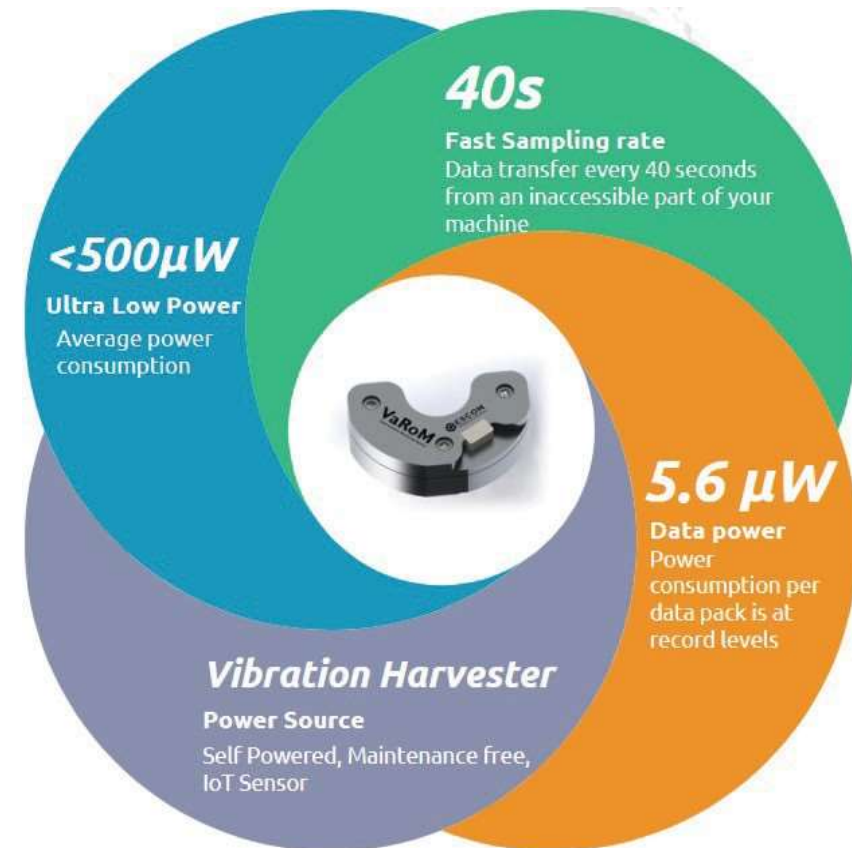

VaRoM will make a great contribution to the digitalization of the engine control and operating system by providing; Valve Rotation Speed (RPM) and Temperature information of the valves, which are one of the most challenging parts to reach and most critical moving parts of the engine.

Thank You For Your Attention!

# VaRoM

Valve Rotation Monitoring



**ESCOM**  
Enhanced Solutions



**VaRoM**  
Valve Rotation Monitoring

[info@escom-es.com](mailto:info@escom-es.com)

Fertek Mah. Organize Sanayi Bölgesi, 7.  
Cadde, 16/1, Nigde, Türkiye

[www.escom-es.com](http://www.escom-es.com)