

Temperature Compensation Attenuator

Feature

- ◆ Attenuation value changes along with temperature.
- ◆ Wide frequency and better characteristic.
- ◆ Small SMT type (2.0mm×1.2mm)
- ◆ Realization of temperature characteristic by adjustment of thermistor characteristic.



Applications

- ◆ Base station, Radio communication, Drone

Type Designation



Dimension

L	W	a1	a2	b1	b2	t
2.00±0.20	1.25±0.20	0.75±0.10	0.88±0.10	0.32±0.10	0.27±0.10	0.55±0.10

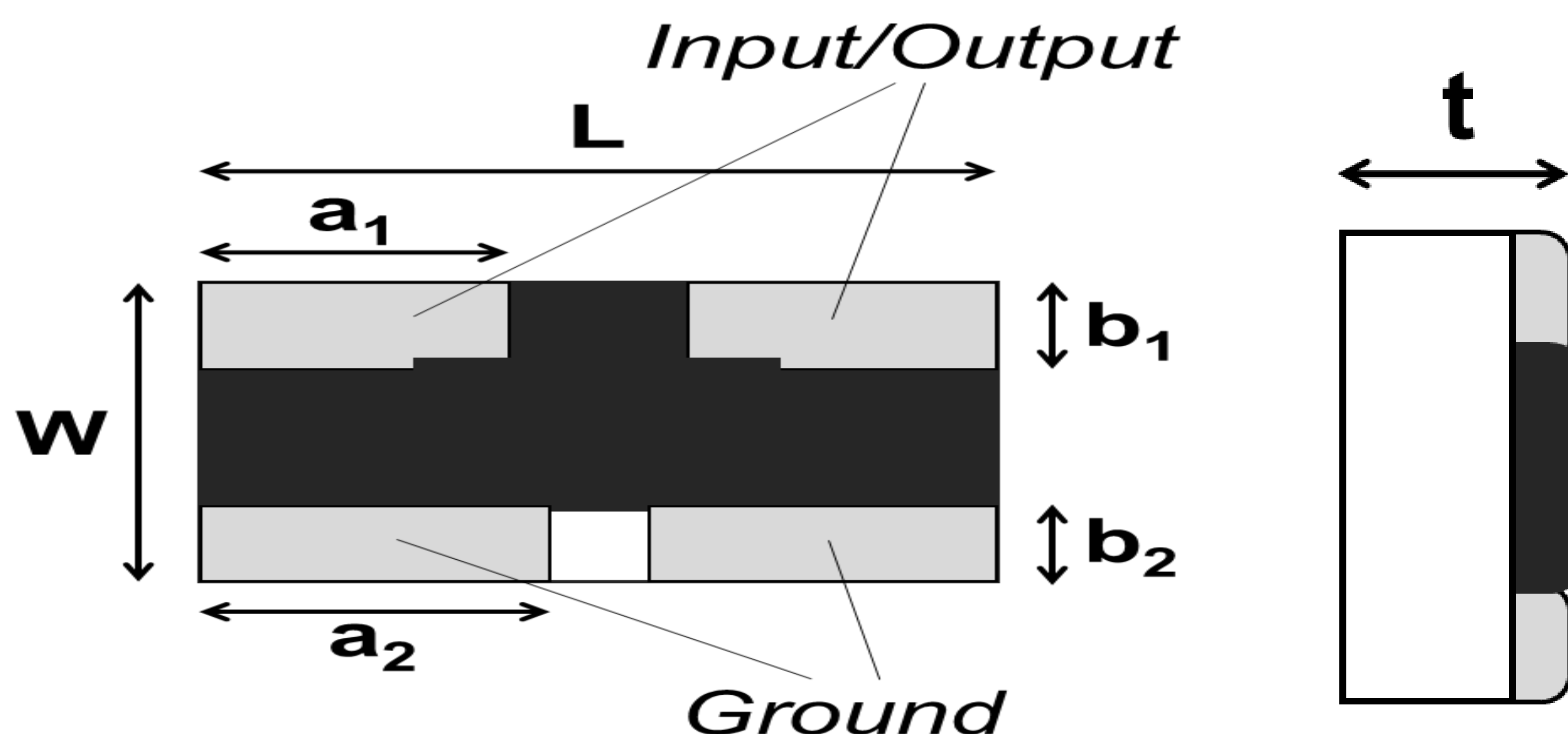

Temperature Compensation Attenuator

Specification

Size	Attenuation Value	Attenuation Tolerance	VSWR	Thermal Sensitive Characteristic
6G 2.00mm×1.25mm	1 ~ 10dB (1dB Step)	±0.5dB (25°C)	<1.5	N1 ~ N9 (1 ~ 3dB) N1 ~ N8 (4 ~ 10dB)

Impedance	Operating Frequency	Rated Power	Operating Temperature	Packaging
50Ω	DC ~ 6GHz	63mW	-40°C ~ 125°C	φ180 reel 1000 or 5000pcs

※ Specification would be changed due to development stage.

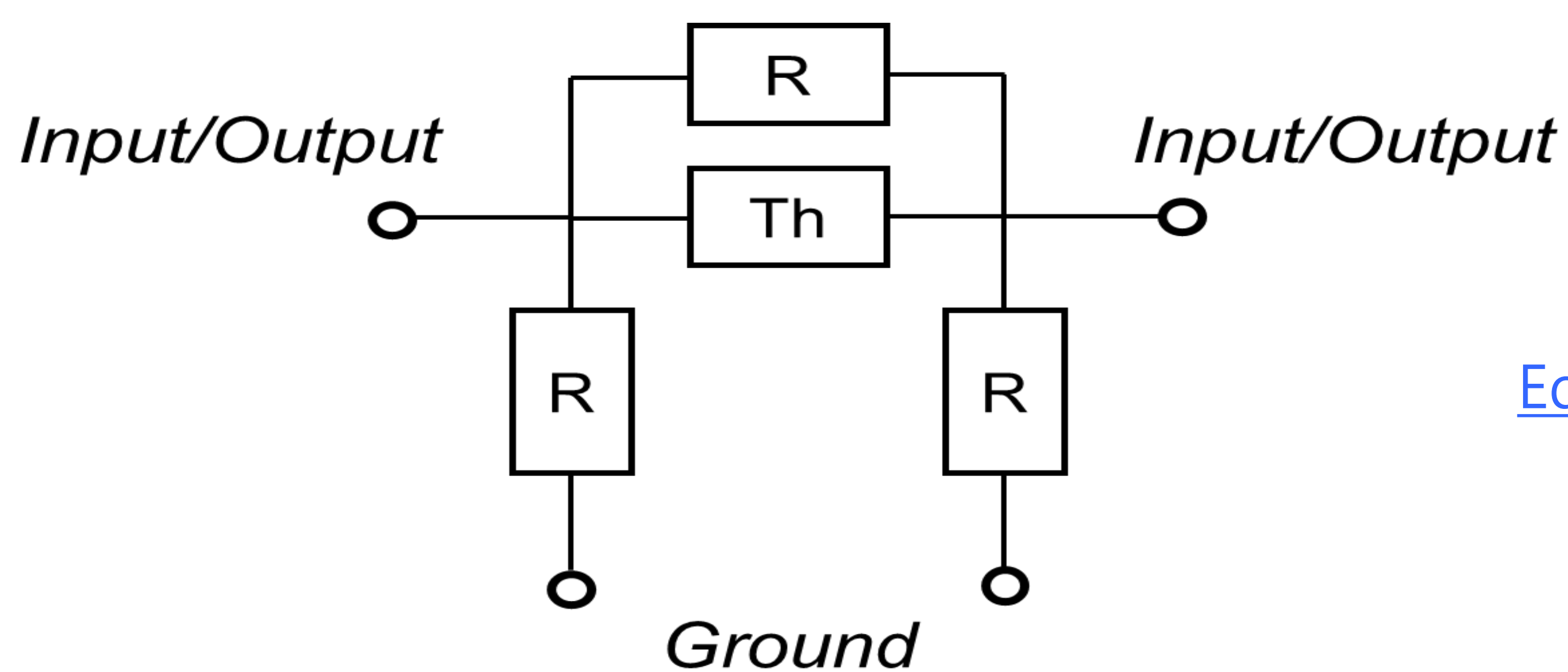

Equivalent circuit

Recommended Land Pattern

(Unit : mm)

a	b	c	d	e
0.80	0.70	0.75	0.50	0.75

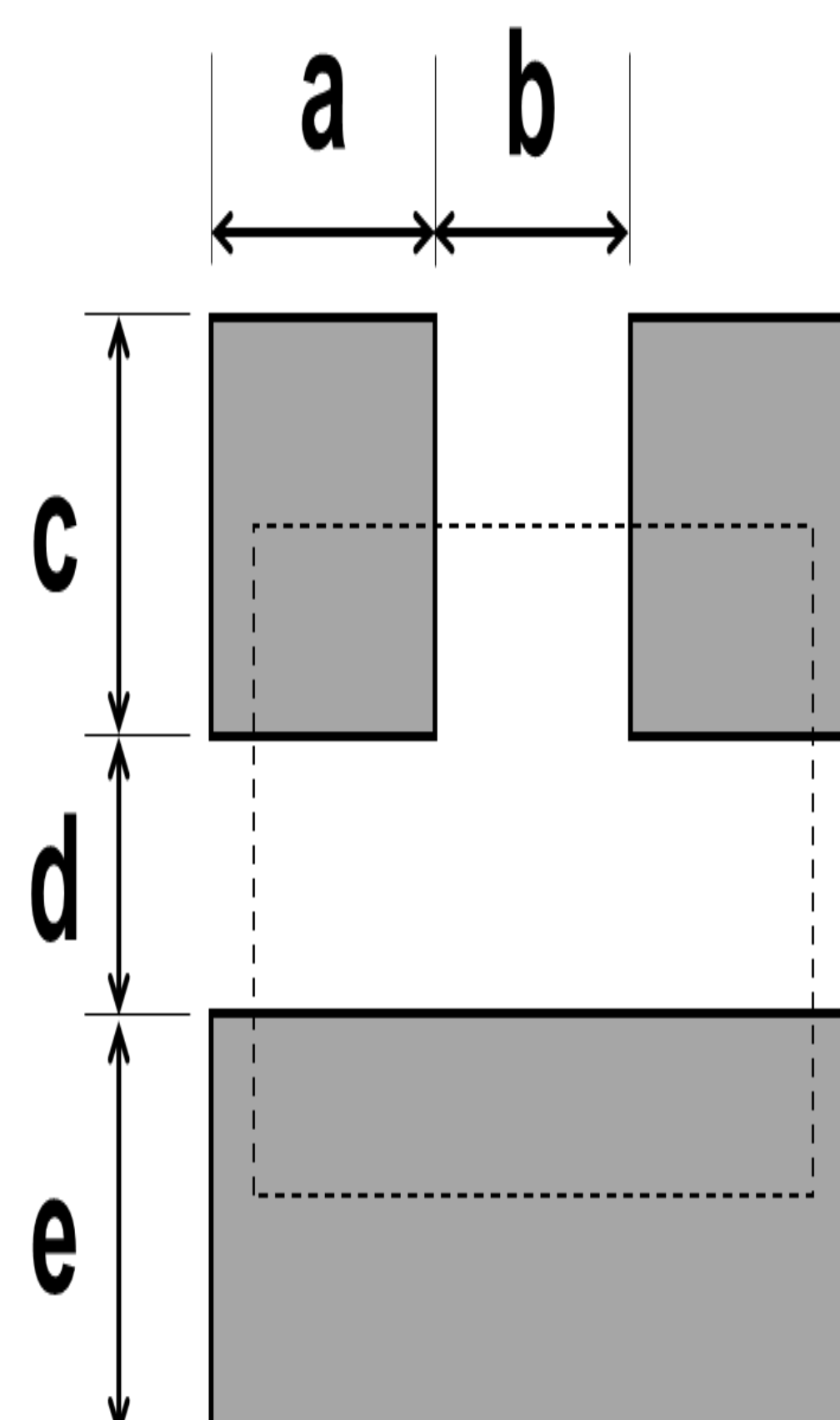

Temperature Compensation Attenuator

Characteristic

- ◆ Size: 2.0x1.2x0.6mm
- ◆ Sensing: 3dB
- ◆ Circuit Type: π
- ◆ Impedance C: 50 Ω

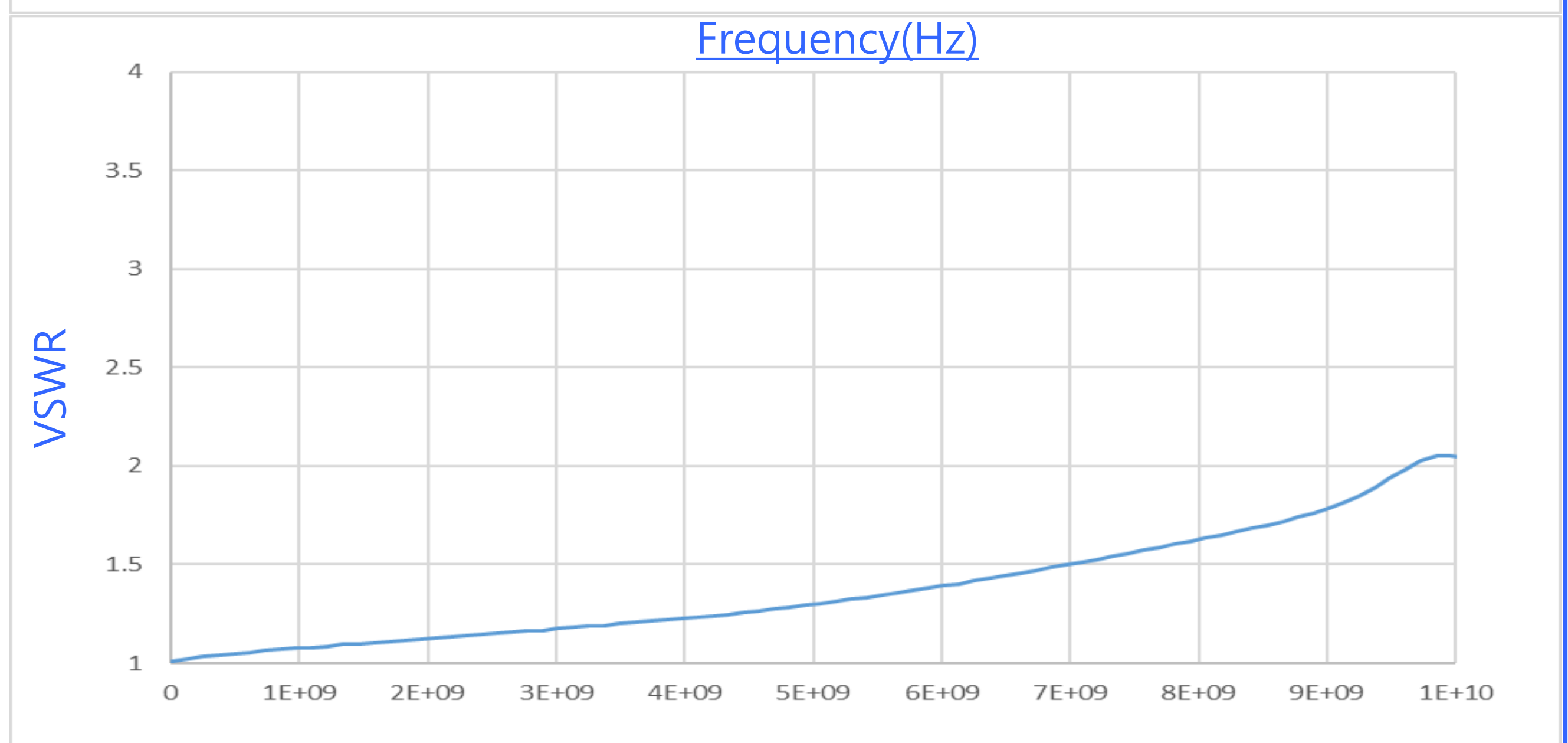
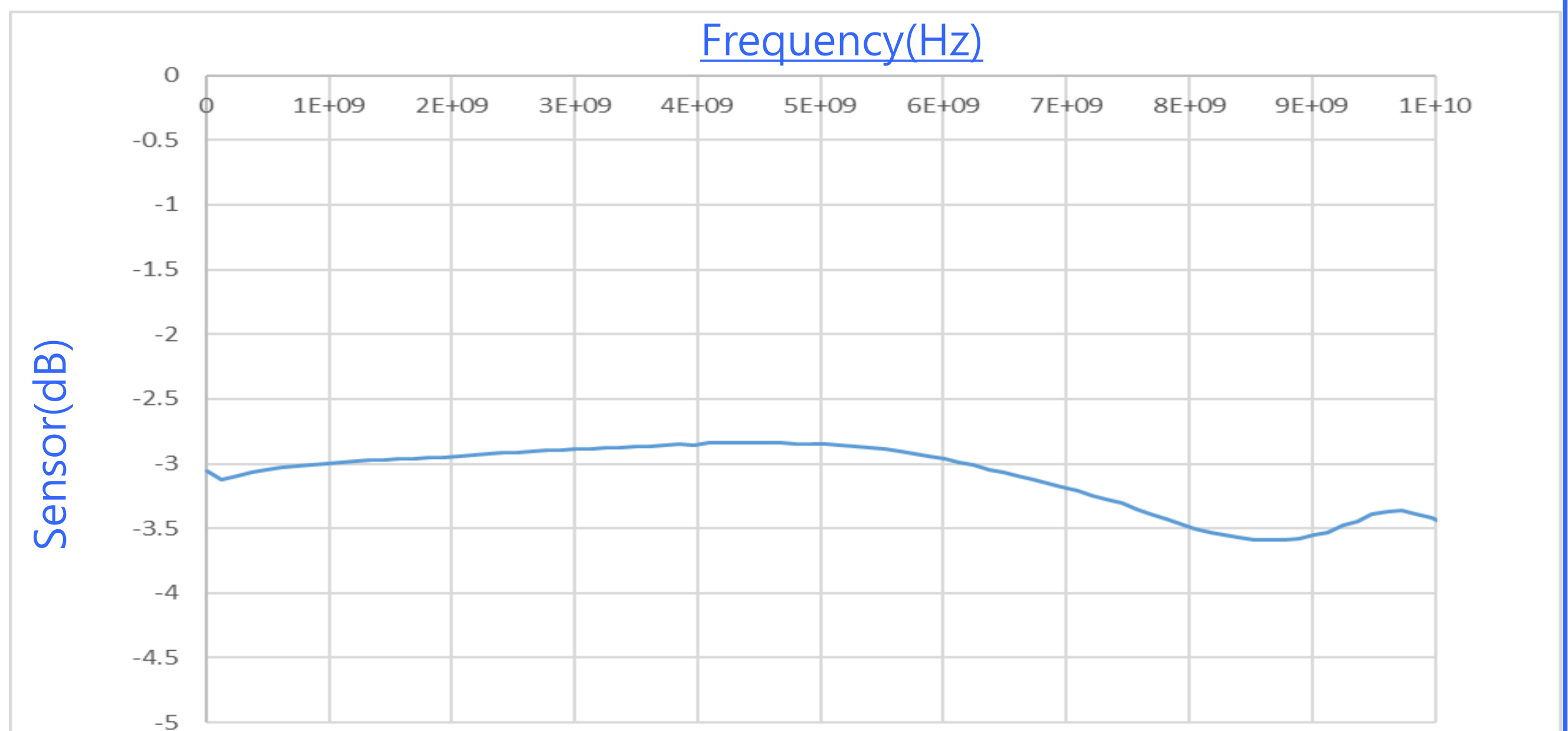
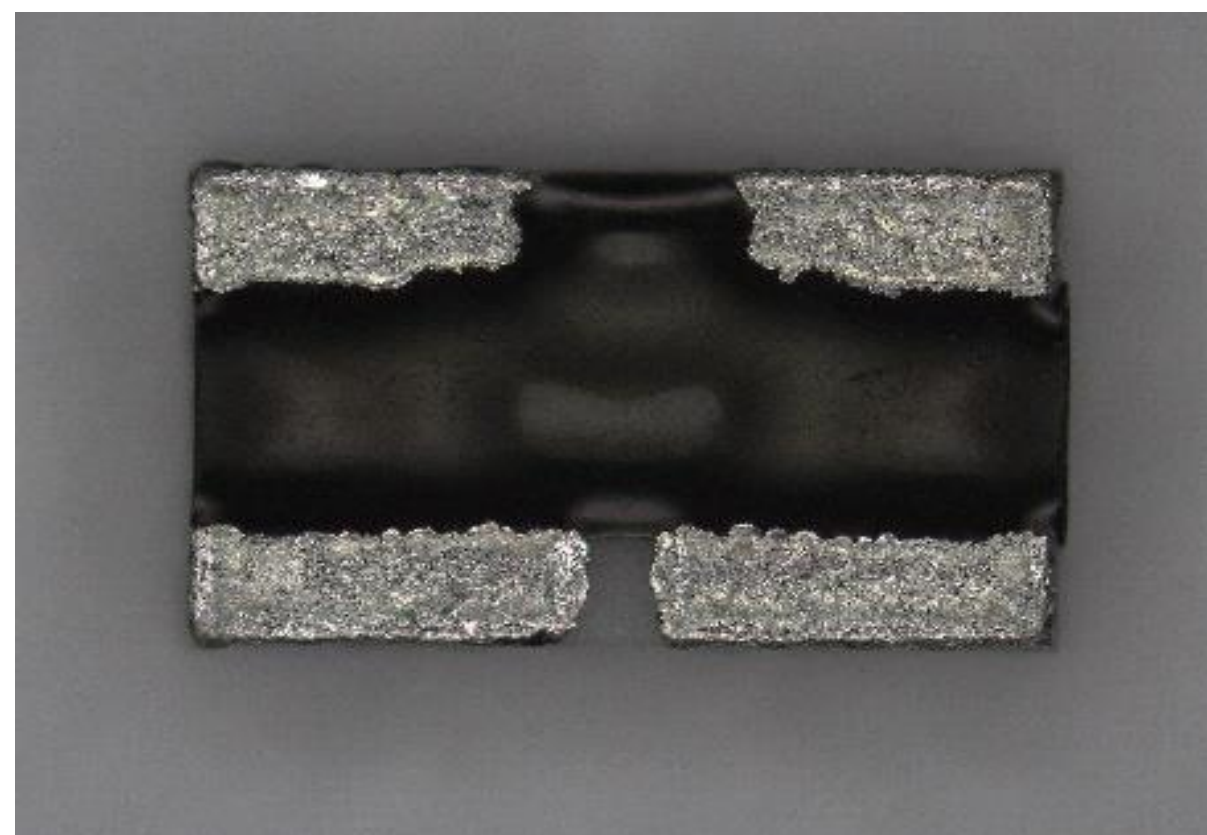

Derating Curve

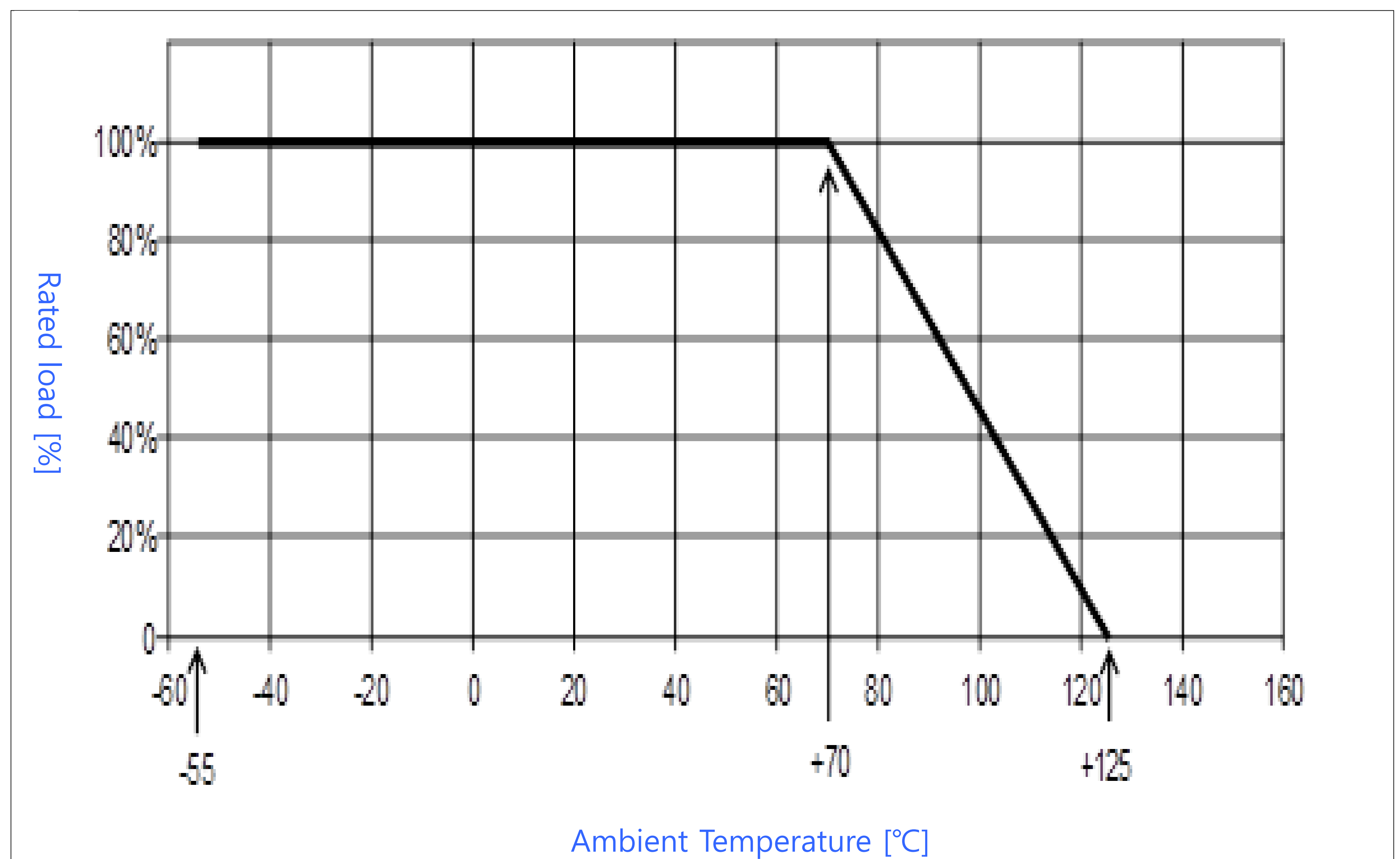

Temperature Compensation Attenuator

Temperature Coefficient of Attenuation

3dB

Thermal Sensitive Characteristic	Temperature Coefficient of Attenuation (25°C/100°C)[dB/°C]
N1	-0.0143
N2	-0.0128
N3	-0.0116
N4	-0.0100
N5	-0.0079
N6	-0.0070
N7	-0.0060
N8	-0.0053
N9	-0.0049

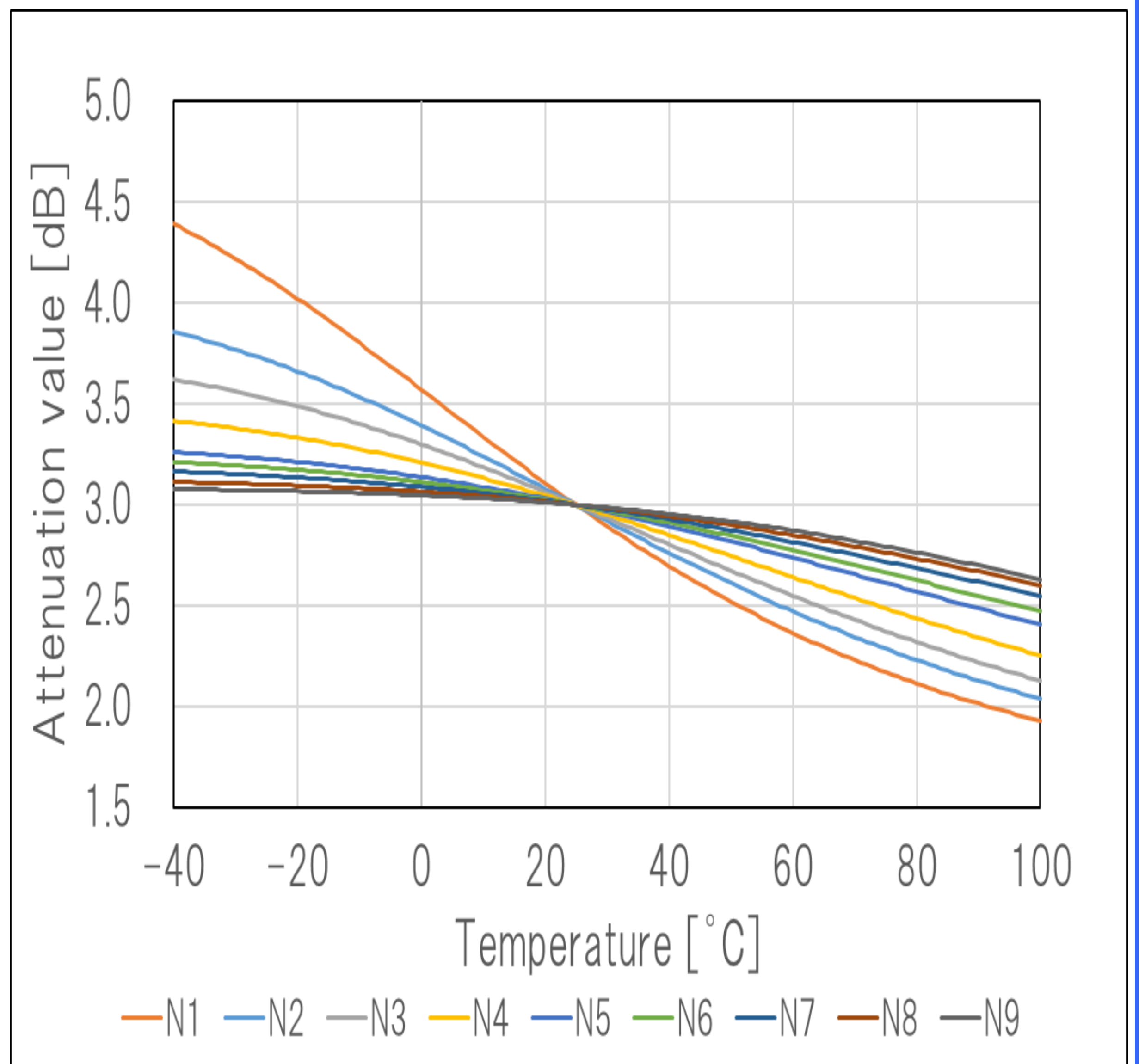

6dB

Thermal Sensitive Characteristic	Temperature Coefficient of Attenuation (25°C/100°C)[dB/°C]
N1	-0.0143
N2	-0.0128
N3	-0.0116
N4	-0.0100
N5	-0.0079
N6	-0.0070
N7	-0.0060
N8	-0.0053

