

SM SERIES | LVDT

Inductive Position Transducer: Standard series that fits nearly all industrial and laboratory applications, highly customisable.

- High precision and linearity
- Various configuration options
- Push-rod guided and unguided, spring loaded
- Stainless steel housing
- Linearity up to 0,10 %
- Measuring range 2...200 mm

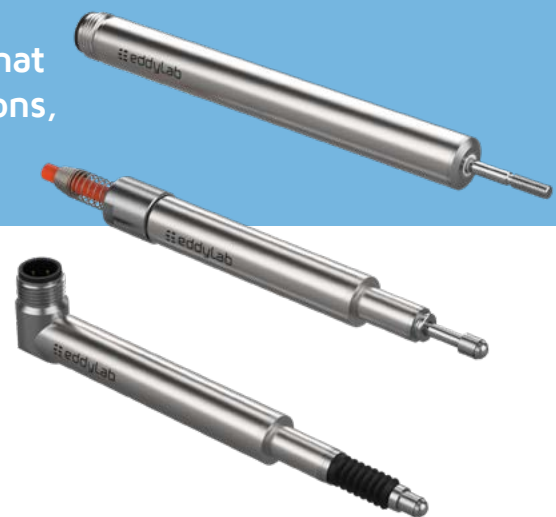

LVDTs (Linear Variable Differential Transformers) are inductive sensors excellent for use in harsh industrial environments, e.g. high temperature and pressure ranges, as well as high accelerations and measuring cycles.

The SM series offers ultimate reliability and precision in a small size, and is designed for industrial and lab use. With a measuring range from 2 up to 200 mm and various configuration options (mechanics, protection class, temperature range, linearity) the SM series ensures to have a suitable measuring system for every application.

The IMCA and KAB electronics (explanation see page 5) have a built-in cable breakage monitoring and are entirely galvanically isolated. The signal output is optimized for interference compatibility with very low residual noise. The guarantee for ultimate resolution and measuring accuracy.

TECHNICAL DATA - SENSORS

SENSOR							
Measurement range FS [mm]	0...2	0...5	0...10	0...25	0...50	0...100	0...200
Linearity [% of FS]	0.30 % (0.20 % optional, 0.10 % for selected models)						
Types	spring loaded (up to range 0...100 mm), free core, push rod guided/unguided						
Protection class	IP67, optional IP68						
Vibration stability DIN IEC68T2-6	10 G						
Shock stability DIN IEC68T2-27	200 G/2 ms						
Supply voltage/ frequency	3 V _{eff} /3 kHz						
Supply frequency	2...10 kHz						
Temperature range	-40...+120 °C (150 °C optional, option H, 200 °C on request)						
Mounting	ø 8 mm h6 clamp diameter or ø 12 mm						
Housing	stainless steel						
Connection	cable output or M12-connector with coupling nut						
cable TPE (standard)	ø 4.5 mm, 0.14 mm ² , non-halogen, suitable for drag chains						
PTFE (option H)	ø 4.8 mm, 0.24 mm ² , max. temperature 200 °C, UL Style 2895						
Max. cable length	100 m between sensor and electronics						
Spring loaded version (up to range 100 mm)							
Spring force (middle of range) [N]	0.9	0.9	0.9	0.95	0.95	1.50	-
Max. cycles of tip at 1 mm amplitude [Hz]	55	50	50	35	20	15	-
Life cycle	> 10 million cycles						
Free core/ push rod/ push rod guided							
Max. acceleration of core/ push rod	100 G						
Life cycle	infinite						
Weight (approx., without cable) [g]	36	42	47	59	85	136	238

TECHNICAL DATA - ELECTRONICS

ELECTRONICS	IMCA EXTERNAL ELECTRONICS*	KAB CABLE ELECTRONICS
Output signal	4...20 mA (load < 300 Ohm) 0...5 V, ± 5 V (load > 5 kOhm) 0...10 V, ± 10 V (load > 10 kOhm)	
Temperature coefficient	-0.0055, ±0.002 %/K	
Resolution*	0.04% of FS	
Corner frequency	300 Hz/-3 dB (6-pole Bessel)	
Isolation stability	> 1000 VDC	
Power supply	9...36 VDC	
Current consumption	75 mA at 24 VDC 150 mA at 12 VDC	65 mA at 24 VDC 140 mA at 12 VDC
Sensor supply	3 V _{eff} , 3 kHz (adjustable, 1-18 kHz)	
Working temperature	-40...+85 °C	
Storage temperature	-40...+85 °C	
Housing	polyamide PA6.6, meets UL94-VO	ABS
Mounting	on DIN EN-rail	bore diameter ø 5,5

* built-in

** 98.5% confidence interval (confidence limit)

TECHNICAL DIMENSIONS

RANGE (FS) [MM]	BODY LENGTH B RADIAL CABLE / CONNECTOR [MM]	BODY LENGTH C CONNECTOR M12 [MM]	CORE LENGTH D [MM]	PUSH ROD LENGTH E [MM]
0...2	64	67	22	54
0...5	70	73	25	60
0...10	80	83	30	70
0...25	110	113	45	100
0...50	160	163	70	150
0...100	260	263	120	250
0...200	460	463	220	450

Other measurement ranges are available on request.

■ TYPE: FREE CORE (D), PUSH ROD UNGUIDED (E)

Free Core (D): Delivery: core (the core extension made of non-magnetic material must be added by the customer).

Push rod unguided (E): delivery: core + core extension

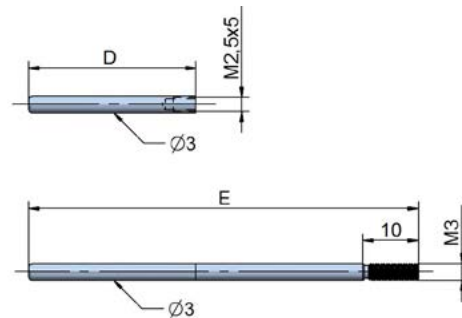
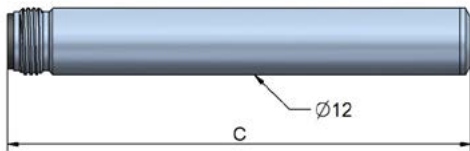

■ TYPE: PUSH ROD GUIDED

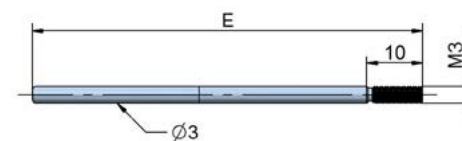
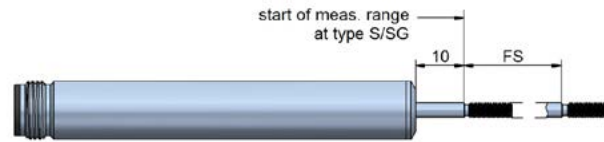
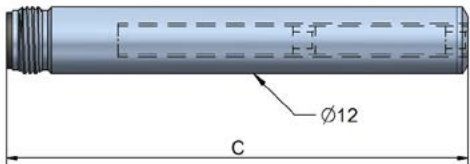

■ TYPE: SPRING LOADED (UP TO RANGE 0...100 MM)

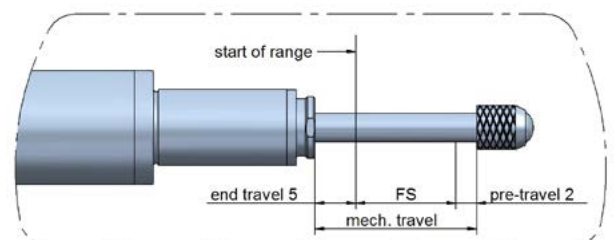
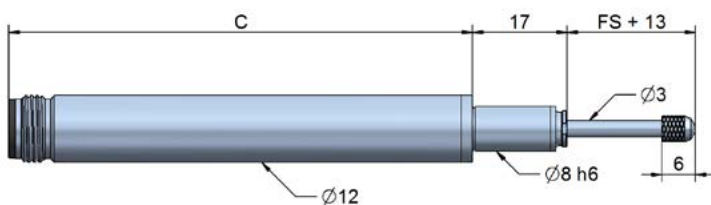

Please note that the stated end travel and start travel (see detailed picture) are standard values. When calibrating the sensors we are aiming for best linearity.

SENSOR TYPES

CONNECTOR / CABLE OUTPUT AXIAL / RADIAL

Sensors with cable output have a cable fitting and a spring for bend protection of the cable. For installation, the bending radius should not be less than 3 times the cable diameter. The standard cable length is 2 m.

Instruments with option H for temperatures up to 150 °C/ 200°C feature a PTFE cable.

For normal application the sensors have a closed rear end body.

Sensors that feature a radial cable output can be supplied with a through hole on request. Please use this version for applications at heavy dirt exposure. The movement of the push rod removes dirt from the sensor and conveys it to the rear. The standard cable length is 2 m.

CONNECTOR OUTPUT (CABLE WITH STRAIGHT OR ANGULAR CONNECTOR)

For sensors with connector output the cable has to be ordered separately. You can choose from a cable with a straight connector or with an angular connector.

The connector is protected from accidental removal by a threaded fitting (M12). The cable lengths are 2/ 5/ 10 m.

The connector pair has protection class IP67.

The total length of the sensor with connector is:

- body length of the connector M12 (see table) + 20 mm (angular connector)
- body length of the connector M12 (see table) + 37 mm (straight connector)

GAITER (OPTION FB FOR SM2...SM25)

A gaiter is available for spring loaded sensors to protect the mechanics from fouling. Note: The gaiter is also available as retrofit kit for measurement ranges from 2 to 25 mm. The working temperature is limited to 0...+120 °C.

X	START OF MEASURING RANGE (0 V / 4 MA)	END OF MEASURING RANGE (10 V / 20 MA)	FULLY EXTENDED
SM2-T	28 mm	30 mm	32 mm
SM5-T	28 mm	33 mm	35 mm
SM10-T	28 mm	38 mm	40 mm
SM25-T	35 mm	60 mm	62 mm

ROD SEAL / WIPER (OPTION W)

A special design of a fluorocarbon sealing is integrated in the sensor front cap. It combines sealing and wiping and ensures a smooth motion of the mechanics.

Note: The end travel is reduced

- from 5 mm to 2 mm for spring loaded sensors
- from 10 mm to 6,5 mm for guided push rod (SG) types

AC-OUTPUT

assignment for TPE-cable:
 white (5): primary 2
 black (6): secondary 2
 brown (9): primary 1
 blue (8): secondary 1

assignment for PTFE-cable:
 white (5): primary 2
 green (6): secondary 2
 yellow (9): primary 1
 brown (8): secondary 1

assignment M12-connector:

CABLE ELECTRONICS KAB

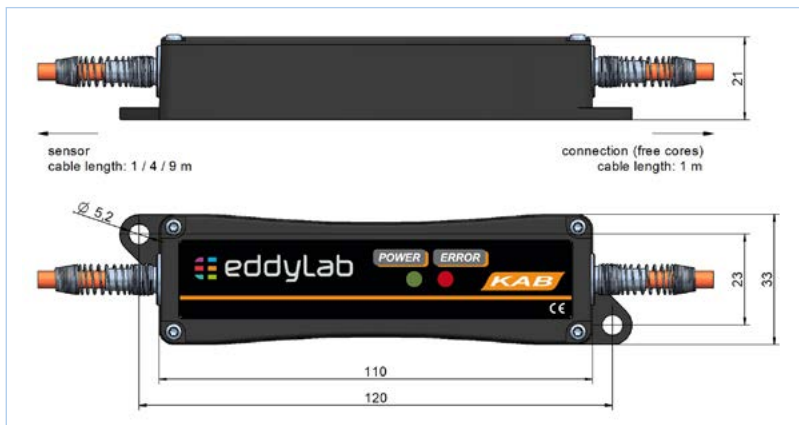

FUNCTION	CABLE TPE	CABLE PTFE-UL
V+	brown	yellow
GND	blue	brown
signal	white	white
signal GND	black	green

If not specified otherwise the cable electronics is placed at 1 m from the end of the cable.

EXTERNAL ELECTRONICS IMCA

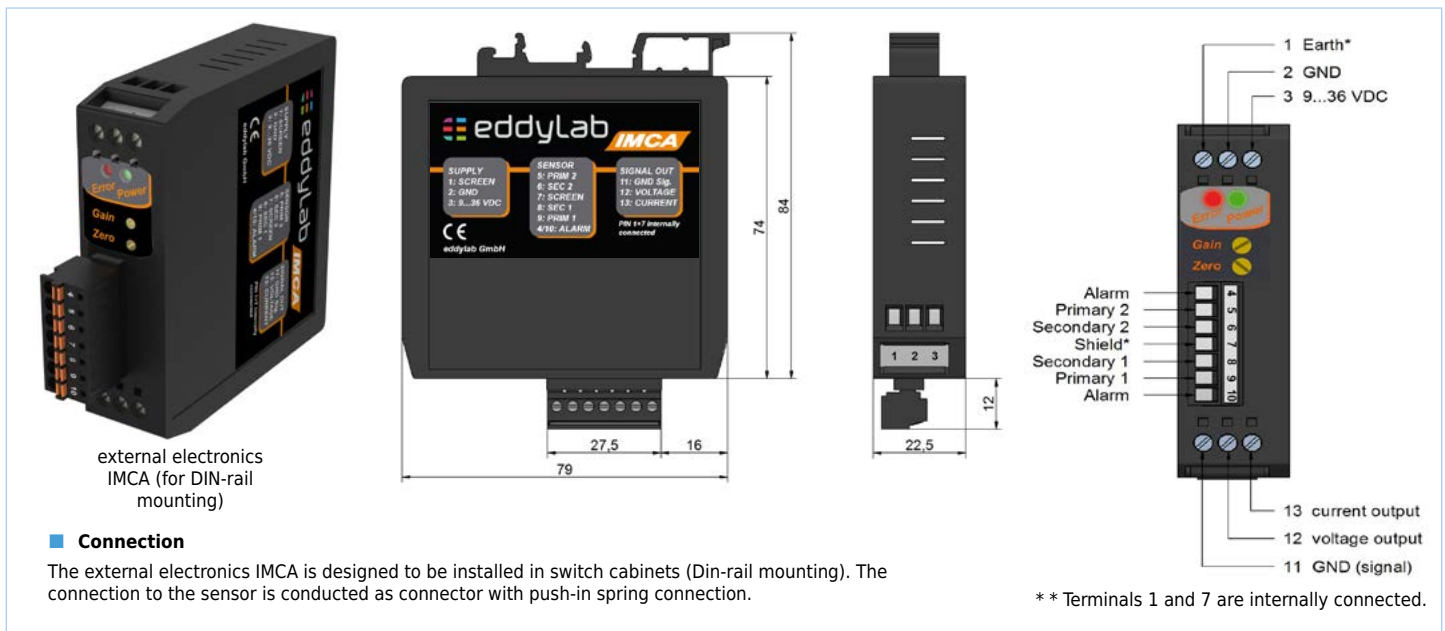

external electronics
IMCA (for DIN-rail
mounting)

■ Connection

The external electronics IMCA is designed to be installed in switch cabinets (Din-rail mounting). The connection to the sensor is conducted as connector with push-in spring connection.

ADJUSTMENT OF ZERO POINT AND GAIN

Each sensor, manufactured by eddylab, is basically adjusted and calibrated. You will receive a traceable calibrated measurement equipment, adjusted and tested in the company's own high-end calibration laboratory, and a calibration certificate. Please note: If the zero point or gain is changed the calibration certificate will lose validity. The potentiometers shall be protected by a label against unauthorised access. In some cases, it is necessary to adjust the zero point and gain, e.g. with hydraulic cylinders or reduced measurement ranges. In this case, the output signal can be adapted to the mechanical stroke of the measurement object precisely. Please note that the zero point and gain may shift for long cable length between sensor and electronics. Thus install the sensor with the according cable length to the electronics and then adjust zero point and gain.

- Push rod entirely in - adjust offset.
Move the sensor to the zero point of the measuring range and set the offset potentiometer on 4 mA/0 V for the output signal
- Push rod entirely out - adjust gain.
Move the sensor to the end of the measuring range (push rod moved out) and set the gain potentiometer on 20 mA /10 V/5 V for the output signal.

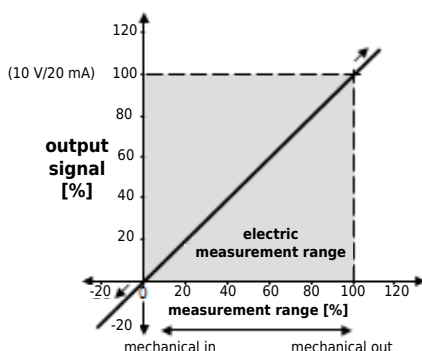

The output signal is referring to the electric measuring range. If the sensor is operated outside the measuring range or the measuring range is exceeded, the signal is also outside the defined range (i.e. > 10 V/20 mA or < 0 V/4 mA, in the graph: > 100 % or < 0 %). Please keep this in mind for control systems with cable break detection lower than 4 mA or for a maximum input voltage > 10 V of measuring instruments. If necessary install the sensor **before** connecting to the PLC.

Running direction of signal: If the push rod is moving into the sensor (e.g. sprung load pushed in), the signal is reducing. If the push rod is moving out, the output signal is increasing. The running direction of the signal can also be inverted.

CABLE BREAK DETECTION

The electronics by eddylab feature a built-in cable break detection. This is achieved by an impedance measurement of the LVDT's secondary coil. If the sensor cable is cut, the impedance on the secondary connections of the electronics change regardless of the push rod position, triggering the cable break detection. This feature is based on a broken secondary connection. A partial cable break of the primary connections (cables between primary coil and electronics) will not activate this function. The electronics vary in their functional range. The external electronics IMCA offers the widest range. The cable electronics KAB only visualises a cable break by a red LED.

IMCA: For the use of the cable break functions an alarm system (signal lamp, acoustic alarm device) or an alarm input of the PLC must be connected to the 7-pole terminal. The circuit board features a analog switch which is a normally open.

■ NORMAL OPERATION IMCA:

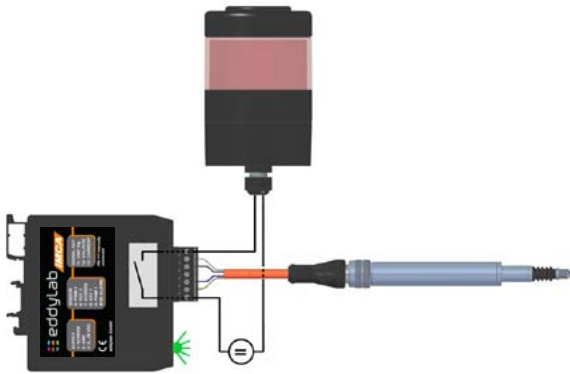

- The green „POWER-LED“ on the front side is on.
- The signal output is active.
- The alarm output is disabled.

■ CABLE BREAK IMCA:

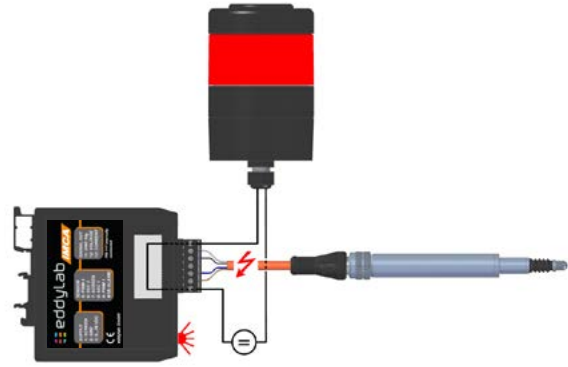

- In case of a cable break the analog switch closes and the alarm system is activated or an electrical signal is conducted. Please note the maximum electrical values: 30 mA or 14 V.
- A front side „ERROR-LED“ flashes in case of an error.
- The signal output is deactivated. There is no current or voltage signal.

■ NORMAL OPERATION KAB:



- The green „POWER-LED“ on the front side is on.

■ CABLE BREAK KAB:



- A front side „ERROR-LED“ flashes in case of an error.

ACCESSORIES

■ MOUNTING PARTS

Flanschklemmstück 1218: flange clamp $\varnothing 12$ mm for SM-series
material: reinforced polyamide
 $\varnothing 18$ mm without reducing bush, $\varnothing 12$ mm with reducing bush (included)

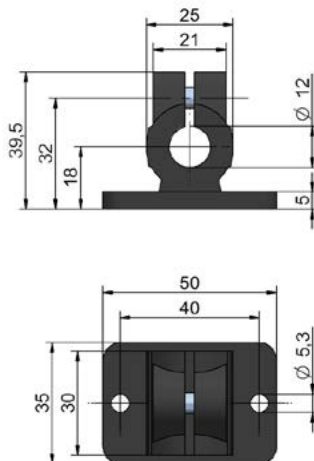

Fußklemmstück 1218: base clamp $\varnothing 12$ mm for SM-series
material: reinforced polyamide
 $\varnothing 18$ mm without reducing bush, $\varnothing 12$ mm with reducing bush (included)

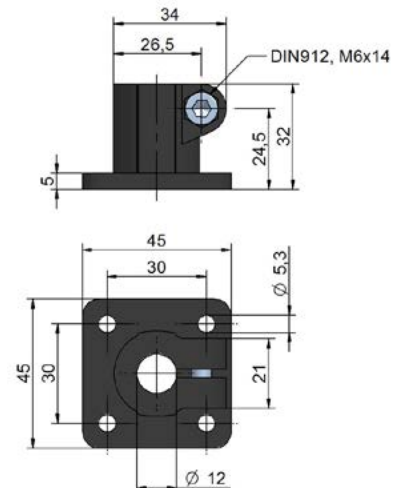

ACCESSORIES

■ CONNECTION CABLE (SHIELDED) FOR CONNECTOR OUTPUT

CABLE M12 ANGULAR CONNECTOR		CABLE M12 WITH STRAIGHT CONNECTOR	
K4P2M-SW-M12	2 m	K4P2M-S-M12	2 m
K4P5M-SW-M12	5 m	K4P5M-S-M12	5 m
K4P10M-SW-M12	10 m	K4P10M-S-M12	10 m



■ MATING CONNECTOR M12 FOR SELF ASSEMBLY (SHIELDED)

	STRAIGHT CONNECTOR D4-G-M12-S	ANGULAR CONNECTOR D4-W-M12-S
Protection class	IP67	
Temperature range	-25...+90 °C	
Mode of connection	spring closure construction	
Cable diameter	ø 4...8 mm	
Conductor	0,14...0,34 mm ²	
	Good chemical and oil resistance	



■ FEELER FOR SPRING LOADED VERSION

MATERIAL OF TASTKOPF-01 FEELER BALLS

steel: for standard applications

ruby: much harder and wear resistant than steel, non-conductive, for all applications except for measuring on aluminium and cast iron

ceramics: comparable to ruby, best choice for measuring on aluminium and cast iron

- Tastkopf-01, steel (standard)
- Tastkopf-01-HM, cemented carbide
- Tastkopf-01-R, ruby
- Tastkopf-01-K, ceramics

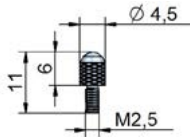

- Tastkopf-02, steel
- Tastkopf-02-HM, cemented carbide

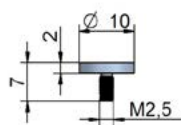

- Tastkopf-03, steel
- Tastkopf-03-HM, cemented carbide

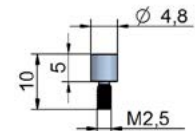

- Tastkopf-04, steel

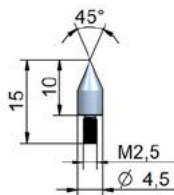

- Tastkopf-05, steel

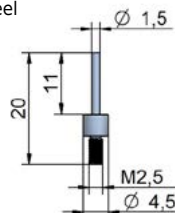

- Tastkopf-782.238, roller

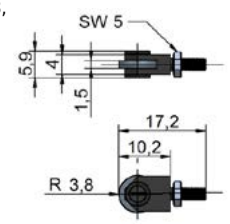

■ RETROFIT GAITER INCL. SECURING RINGS

for SM2	Set-FB-2
for SM5	Set-FB-5
for SM10	Set-FB-10
for SM25	Set-FB-25



ORDER CODE SENSOR

SM **X** - **X** - **X** - **X** **X** **X** **X** **X** **X** **X** **X**

a **b** **c** **d** **e** **f** **g** **h** **i** **j**

a measurement ranges [mm]

2 / 5 / 10 / 25 /
50 / 100 / 200

b type

A = free core
S = unguided push rod
SG = guided push rod
T = spring loaded

c cable/ connector

KA = axial cable output
KR = radial cable output
SA = axial connector output M12
SR = radial connector output M12

d cable / connector output

S1: sensor with connector output

1 = connector output M12 (no cable)

S2: sensor with cable output, open cable end (for IMCA)

A = TPE cable 2 m
B = TPE cable 5 m
C = TPE cable 10 m
D = PTFE-UL cable 2 m (option H)
E = PTFE-UL cable 5 m (option H)
F = PTFE-UL cable 10 m (option H)

S3: sensor with cable output for KAB

G = TPE cable 2 m
H = TPE cable 5 m
J = TPE cable 10 m
K = PTFE-UL cable 2 m (option H)
L = PTFE-UL cable 5 m (option H)
M = PTFE-UL cable 10 m (option H)

e linearity

1 = 0,30 % (standard)
2 = 0,20 % (option L20)
3 = 0,10 % (option L10)

f temperature range

1 = -40...+120 °C (standard)
2 = -40...+150 °C (option H)
3 = -40...+200 °C (option H200)

g push rod sealing

1 = - (standard)
2 = gaiter (option FB)
3 = wiper ring (option W)

h protection class

1 = IP67
2 = IP68 (option IP68)

i housing

1 = stainless steel

j spring force

1 = for type „A/S/SG“
2 = standard
3 = HD2.5 (approx. 250g)
4 = HD (approx. 500g)

ORDER CODE ELECTRONICS

IMCA - 24V - **X**

a

KAB - 24V - **X** - **X**

a **b**

type

IMCA = external electronics
KAB = cable electronics

a output signal

020A = 0...20 mA
420A = 4...20 mA
10V = 0...10 V
5V = 0...5 V
±5V = -5...5 V
±10V = -10...10 V

b KAB: type of cable / length

E1: for sensor with cable output

- = KAB integrated in sensor cable

E2: for sensor with connector output

A = cable 2 m, M12 straight female conn.
B = cable 2 m, M12 angular female conn.
C = cable 5 m, M12 straight female conn.
D = cable 5 m, M12 angular female conn.
E = cable 10 m, M12 straight female conn.
F = cable 10 m, M12 angular female conn.

b KAB: type of cable / length

E3: for sensor with cable output

M12 = KAB integrated in sensor cable, M12 connector

E4: for sensor with connector output

M12A = cable 2 m, M12 straight female conn., M12 conn.
M12B = cable 2 m, M12 angular female conn., M12 conn.
M12C = cable 5 m, M12 straight female conn., M12 conn.
M12D = cable 5 m, M12 angular female conn., M12 conn.
M12E = cable 10 m, M12 straight female conn., M12 conn.
M12F = cable 10 m, M12 angular female conn., M12 conn.

possible combinations:

- S3+E1: sensor with cable output, KAB integrated in sensor cable
- S3+E3: sensor with cable output, KAB integrated in sensor cable, M12 connector
- S1+E2: sensor with connector output, cable electronics with cable K4PxM
- S1+E4: sensor with connector output, cable electronics with cable K4PxM, M12 connector

- IMCA: sensor with connector output (S1), cable K4PxM, external electronics IMCA
- IMCA: sensor with cable output (S2), external electronics IMCA

